

Honeywell Process Solutions

Mini-Max **PTZ Gas Volume Corrector for** **Standard Meter Applications**

User Manual

October 2010



Introduction.....	5
Specifications.....	6
Quick Start Guide.....	9
Correction Factors to Metered Volume.....	12
How the Mini-Max Works.....	14
Receiving the Mini-Max.....	18
Function Check.....	18
Standard Instrument Mounting.....	20
Meter Rotation.....	20
To Change Rotation, if necessary.....	21
Installing a Mini-Max without an Instrument Drive.....	21
Installing or Changing Battery Packs.....	23
Serial Connector.....	26
Communicating to the Mini-Max with a Modem.....	31
Modem Power Control.....	33
Alarms.....	34
Pulse Outputs.....	36
Digi-Span fuel switching feature.....	38
Mini-Max Operating Modes.....	39
Default Meter Reader Display.....	42
Live Parameters Display.....	45
Audit Trail.....	45
Instrument Calibration.....	46
Taking the Mini-Max “Unconfigured”.....	53
Putting the Mini-Max into “Shutdown”.....	54
Firmware Reprogramming.....	55
Item Code List	65
Parts List, Meter Mount Mini-Max	96
Parts List, Wall Mount Mini-Max	100
Drawing, Installation for Div. 1 Locations.....	104
Drawing, Installation for Div. 2 Locations.....	105
Drawing, Installation for Div. 1 Locations (CSA)	106
Drawing, Installation for Div. 2 Locations (CSA).....	107
Index.....	108

Mini-Max Users Guide

Revision List

1.00	Initial Release			July 2000
1.10	Added:	Extended Audit Trail	p81-82	
		Digi-Span Fuel Switching	p82	
	Modified:	Table of Contents	p3	January 2001
1.11	Modified:	Power Specifications	p6	
		RSI wiring table	p20	July 2001
2.00	Added:	Alarm Call-In	p32	
		Modem Power Control	p34	
	Modified:	Item Code List	p54-85	
		Table of Contents	p3	
		Audit Trail	p46	
		Specifications	p7	
		Supercompressibility Factor	p12	
		Index	p90-91	
	Moved:	Digi-Span Fuel Switching	p39	March 2002
3.00	Added:	LCD Diagnostic Function	p27	
		Serial I/O Board	p27	
		Modem and I/O board drawings	p28-30	
		Items 483, 658 and 660	p86-87	
	Modified:	Item 129 Description	p71	
		CSA Installation Drawings	p92-93	
	Page Shift:	Inserted 3 pages at 26	p27-93	June 2003
3.01	Added:	Parts Lists	p96-103	
	Modified:	Firmware Upgrade Procedure	p55	
		Pulse Outputs	p36	October 2003
3.03		Honeywell update		October 2010

Introduction

The Mini-Max is a stand alone, electronic gas volume corrector. Its standard mounting is on rotary, turbine, and diaphragm meters that have a rotating shaft (instrument drive) output. The Mini-Max is also compatible with meters that provide low frequency pulses. The purpose of this Operator's Guide is to provide the information necessary to install and use the Mini-Max.

The Mini-Max is smaller than the Mercury Instrument's Mercor Mini-AT and provides the user with simplified operation. A PC (desktop or laptop computer) is needed to configure and download the Mini-Max using Mini-Max Link or MasterLink32 software. Detailed information regarding the software is available through the Mini-Max Link Software Users Manual, or through the Mini-Max Link help screens.

In addition to its small, sturdy case, the Mini-Max offers these and other features:

- High-performance, low power microprocessor
- Extended battery life
- Audit Trail memory capacity (40 days of daily)
- FLASH memory (hence, no plug-in EPROMs)
- Field programmable firmware updates
- Two Form-A outputs for Volume and one Form-A output for Alarms
- Software selectable Pulse Widths for volume pulses
- Serial port with automatic baud rate settings
- High-speed data transfers (up to 38.4 kbaud)
- On-board surge protection for serial & pulse data
- Field replaceable Alkaline batteries

Specifications

Input Volume

- Dual Dry-reed switches, one pulse per each meter revolution
- Uncorrected volume totalized on mechanical index, also displayable on LCD (Liquid Crystal Display)
- Input pulse counting continues for one half hour without main battery

Input Pressure

- Precision strain gauge pressure transducer compensated to minimize ambient temperature effects
- Standard Transducer Ranges:

Pressure Range Transducer Type

PSI	BAR	Transducer Type
0-1	0.07	Gauge only
0-3	0.2	Gauge only
0-6	0.4	Gauge only
0-15	1.0	Gauge only
0-30	2.0	Gauge or Absolute
0-60	4.0	Gauge or Absolute
0-100	7.0	Gauge or Absolute
0-300	20	Gauge or Absolute
0-600	41	Gauge or Absolute
0-1000	70	Gauge or Absolute

- Live display of input pressure on LCD

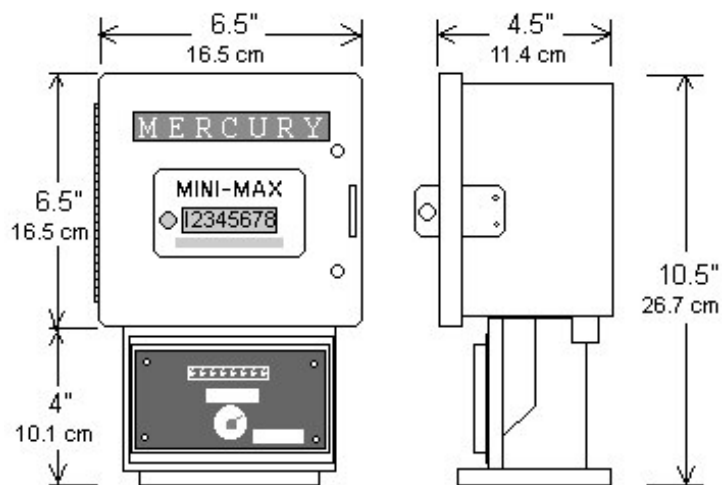

Input Temperature

- Highly stable, solid state temperature sensor in a sealed ¼" diameter, 6" long stainless steel probe with 6' shielded conductor and ½" NPT slip-along fitting to match thermowell
- Range: -40°F. to 150°F. (-40°C. to 65.5°C.)
- Live display of input temperature on LCD

Corrected Volume

- Corrected to desired Base Pressure & Base Temperature
- Corrected for Supercompressibility (NX-19)
- Selectable volume units, both Metric & Imperial
- Displayed continuously on 8-digit x ½" LCD

Power

- 3.8 to 15.0 VDC (**maximum 6VDC for Ex installations**)
- Battery life: 4 years+ (with standard Alkaline Disposable Batteries)
- Half hour operation with batteries removed
- 2 Month low battery warning with 1 month additional reserve (LCD will display HELP)
- Main battery voltage and alarms displayable on LCD

Output Volume for data collection systems

- Two Form-A for Volume and one Form-A for Alarms
- Software selectable pulse width (default = 62.5 msec.)
- Optional mechanical uncorrected volume switch

Memory

- Audit Trail: 40 days of daily
- Flash: Resident firmware (upgradable via laptop)
- E²PROM: Resident pressure compensation coefficients and critical calibration / configuration item values

Accuracy

(Maximum error at reference conditions including linearity, repeatability and hysteresis.)

- Computation: $\pm 0.3\%$ of corrected volume reading
- Pressure transducer: $\pm 0.4\%$ of full scale
- Temperature Sensor: $\pm 1.0^\circ\text{F}$.
- Combined computation: $\pm 0.5\%$ of full scale
(pressure & temperature)

Ambient Temperature Effects

From -40°F to 150°F (-40°C to 65.5°C)

- Total: $\pm 0.1\%$ of corrected volume per 100°F .

Long Term Stability

- Total: $\pm 0.5\%$ of corrected volume per year.

Environmental Conditions

- Ambient Temperature -40°F . to 150°F . (-40°C . to 65.5°C .)
- Ambient Humidity: 0 to 100% Non-condensing.

Enclosure

- Aluminum, white powder coat paint
- Lexan viewing windows for uncorrected mechanical index, corrected volume LCD
- UL, CSA
- Mounting plate with gasket and bolts to accommodate most meters

Certifications

- UL listed for Class I, Division 1 & 2, Group D
- **CSA listed for Class I, Division 1 & 2, Groups C & D**

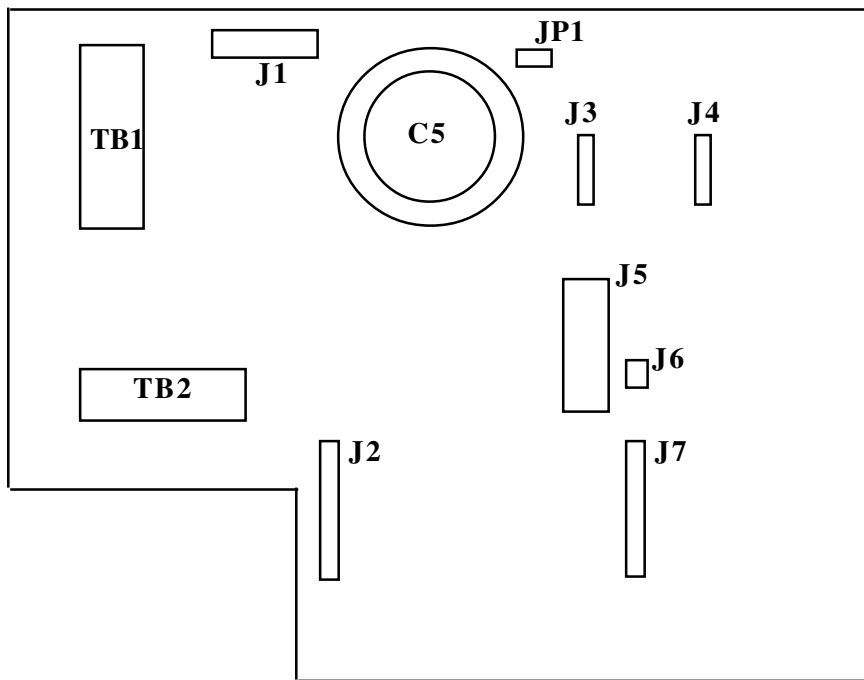
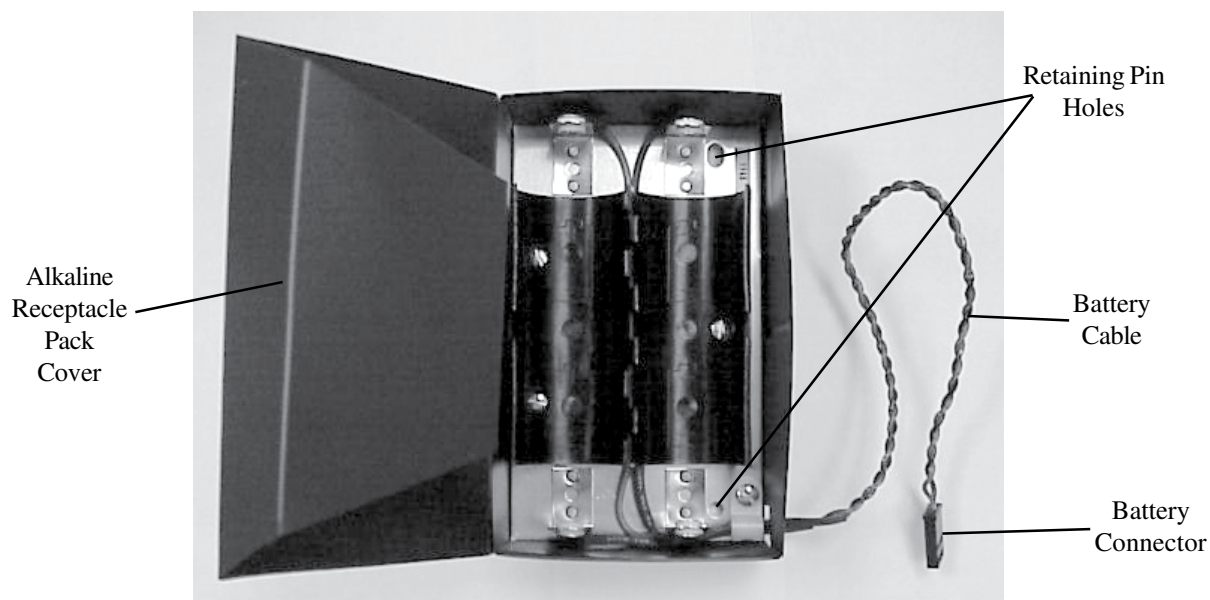
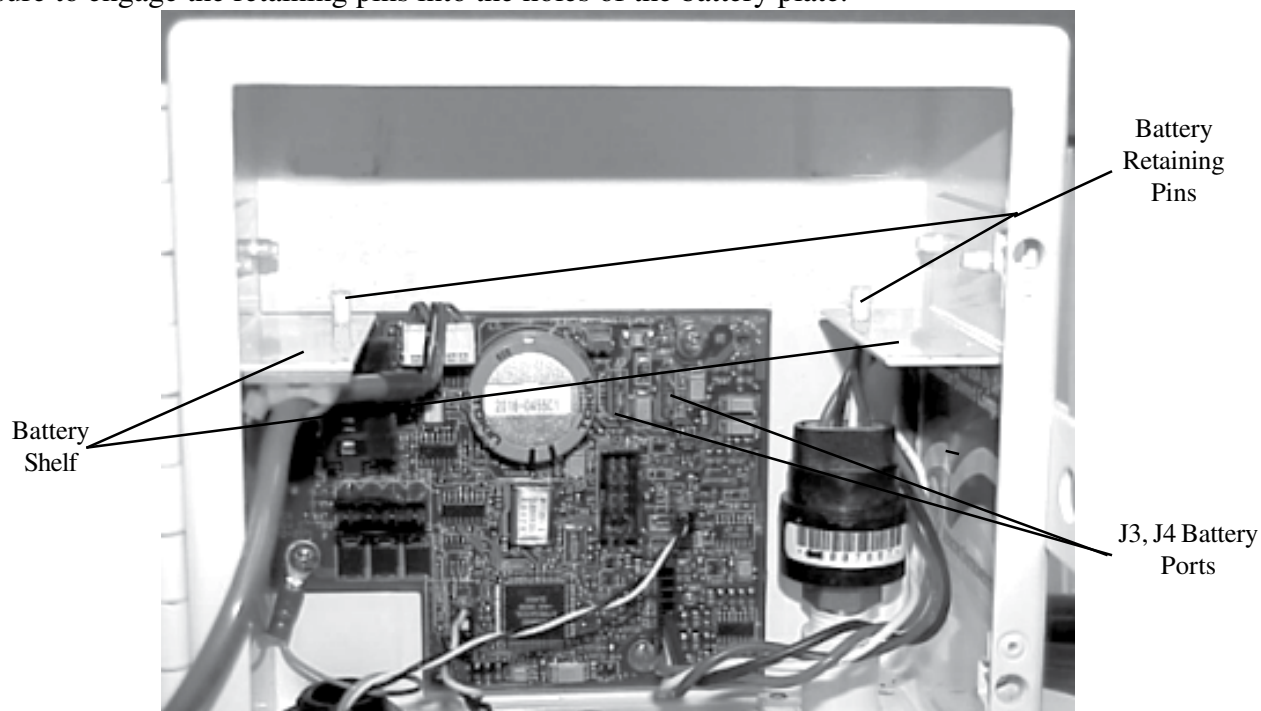

Fig. 1
Diagram of the Mini-Max Board
(Actual Size)

Connector / Jumper	Purpose
J1	Connection for LCD Display
J2	Connection for Input Switch Board
J3, J4	Connection for main battery
J5	Connection for serial port, modem
J6	Connection for temperature input
J7	Connection for pressure input
TB1	Surge protected output for Volume Pulse A,B, and Alarm Pulse
TB2	Connection for Remote UncVol switch input
C5	Super Cap
JP1	Super Cap disconnection Jumper

The following steps will guide you to getting the Mini-Max instrument installed and operational.

1. Carefully unpack the instrument and verify that there is no shipping damage, also verify that nothing is missing from the shipment.
2. Open the case door and make sure there are no loose connections or loose hardware.
3. Install four new D-cell batteries if using the Alkaline Receptacle Pack. Plug the battery connector into either J3 or J4. Position the battery on the battery shelf located above the mainboard. Be sure to engage the retaining pins into the holes of the battery plate.



4. Verify that digits appear in the LCD display (usually all zeroes). Scroll through the meter reader list by pressing “MI” logo button to verify the instrument is operating.



5. Connect the MPA ribbon cable into the serial port (J5), and connect a standard serial cable from the MPA to a computer serial port.

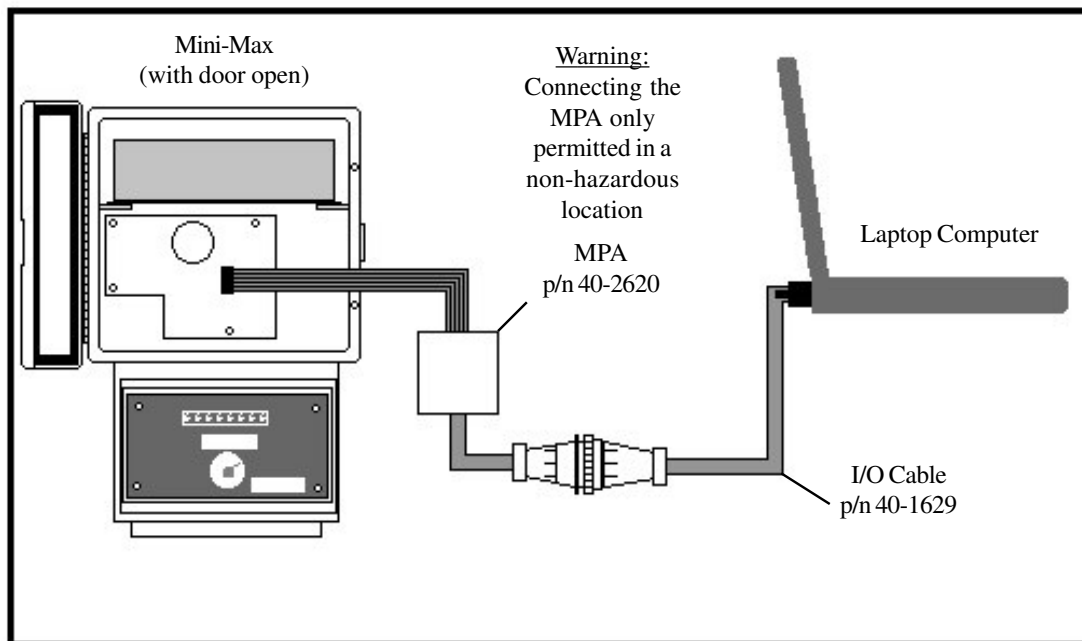

6. Run Mini-Max Link and use the “Set Instr. Date/Time via Computer” selection in the File Menu to set the date and time in the instrument.
7. Use Mini-Max Link software to verify that company and site specific items are set properly, especially item 98 (Meter Index Code).
8. Use the “Disconnect Link” function in the Instrument menu to return the Mini-Max back to corrector mode. Remove the MPA connector from J5.
9. Place the Mini-Max on the meter, making sure that the wiggler is aligned properly. Bolt the Mini-Max to the meter.

10. Verify the Test Hand rotates in the proper direction. If not, remove the black mechanical index assembly and shift the lower bevel gear to the proper location.

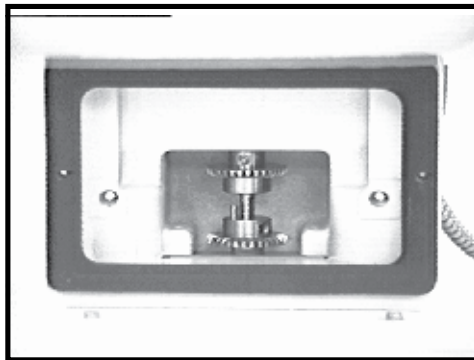

Bevel Gear DOWN for CW

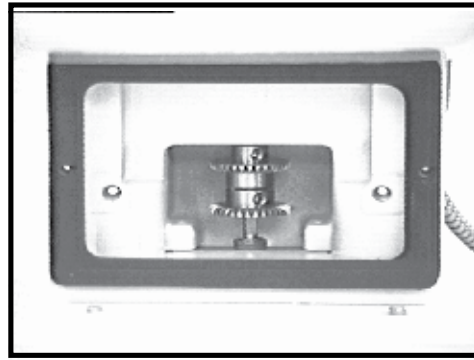

Bevel Gear UP for CCW

11. Connect the Pressure line to the 1/4" NPT fitting at the bottom of the instrument.

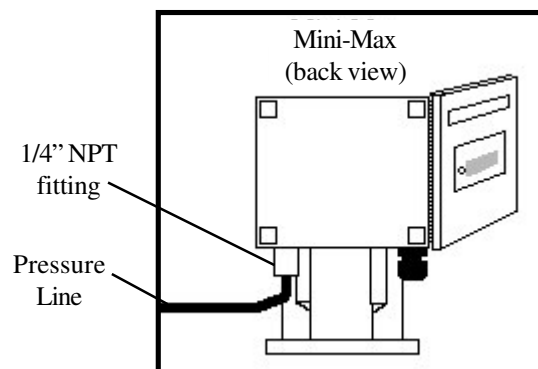

12. Insert the slip-along fitting into the thermowell, and place the temperature probe into the slip-along fitting, sliding the probe down until it bottoms out in the thermowell before tightening the slip-along nut

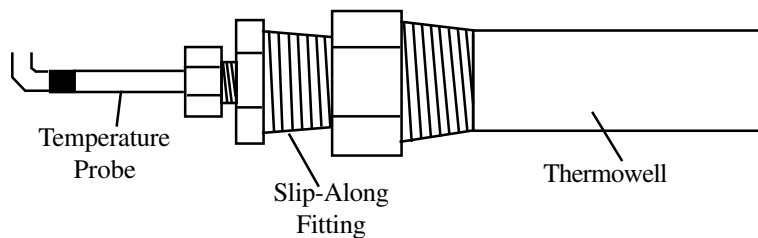

13. At this point the instrument should be ready

Correction Factors to Metered Volume

Ideal or perfect gases follow the relationship of Boyle's Law for pressure effect and Charles' Law for temperature effect, which can be stated: The volume of any definite weight of a perfect gas varies inversely with change in absolute pressure and directly with change in absolute temperature. The equation for this relationship of the two laws is expressed as follows:

$$\frac{V1 * P1}{T1} = \frac{V2 * P2}{T2}$$

The Symbols V1, P1 and T1 refer to the original volume, pressure and temperature while V2, P2 and T2 refer to the volume, pressure and temperature of the new or changed conditions. Rearranging the equation and rewriting subscripts, we can express it as follows:

$$Vb = Vm * \frac{(Pm * Tb)}{(Pb * Tm)}$$

Where: Vb = gas volume (cu. Ft.) at base condition corrected
Pb = absolute base pressure (psia)
Tb = absolute base temperature (deg. R)
Vm = gas volume metered (cu. Ft.) uncorrected
Pm = absolute meter pressure (psia)
Tm = absolute meter temperature (deg. R)

Pressure Factor Fp

The pressure factor (Fp) to apply to metered volume is expressed by the Boyle's Law relationship as follows:

$$Fp = \frac{Pm}{Pb} = \frac{\text{Meter Pressure (PSIG)} + \text{Atmospheric Pressure (PSIA)}}{\text{Base Pressure (PSIA)}}$$

Each increment of meter pressure represents a different pressure factor. As the flowing gas pressure (Pm) changes, the Mini-Max automatically applies the pressure factor (Fp) to the metered volume (Vm).

Temperature Factor Ft

The temperature factor (Ft) to apply to metered volume is expressed by the Charles' Law relationship as follows:

$$Ft = \frac{Tb}{Tm} = \frac{\text{Base Temperature, deg F} + 459.67}{\text{Meter Temperature, deg F} + 459.67}$$

Each increment of meter temperature represents a different temperature factor. Therefore, as the flowing gas temperature changes, the Mini-Max automatically applies the temperature factor (Ft) to the metered volume.

Supercompressibility Factor Fpv

Gases actually behave in a manner slightly different from what the ideal gas laws indicate. This deviation depends on the molecular composition of the gas and the specific gravity as well as the pressure and temperature. Natural gas, for instance, compresses by a greater amount than that computed by Boyle's law and hence the term "supercompressibility" is used for this deviation. It is small at very low pressure, but becomes substantial as the pressure increases. The Mini-Max automatically applies the supercompressibility factor and therefore the equation for total volume correction that the Mini-Max applies to metered volume, is expressed as:

$$V_b = V_m * F_p * F_t * (F_{pv})^2$$

Where:

- Vb = gas volume (cu. Ft.) at base condition corrected
- Vm = metered volume read from meter index
- Fp = pressure factor
- Ft = temperature factor
- Fpv = supercompressibility determined from NX-19 or AGA-8

The Mini-Max automatically squares the supercompressibility factor displayed, which is based on the pressure and temperature sensed at the meter. The resulting volume readout is corrected for pressure, temperature, and supercompressibility.

NX-19 vs AGA-8 Supercompressibility

The Mini-Max can calculate the supercompressibility factor by one of two different methods. The first method is NX-19 which uses a table built into the Mini-Max firmware. The second method is AGA-8 which is a table generated by Mercury Instruments AGA-8 Table Generation Utility, and sent to the Mini-Max using MasterLink32.

How the Mini-Max Works

The Mini-Max is a dedicated microcomputer that uses precision sensors to measure gas pressure and temperature and corrects metered volume. The electronic circuits are powered by the battery pack located inside the case. The battery voltage is regulated to the various voltages required by the remaining circuits. While in the Corrector Mode, most of the electronic circuitry is in an 'unpowered' (sleep) state. When the magnet disc rotates and actuates the input switches, the electronics are energized and begin the correction cycle. The input switches not only 'wake-up' the electronics, but are also the input for uncorrected volume. The volume that each input closure represents is defined by Item Code 098 multiplied by the value at Item Code 114.

Once the instrument 'wakes-up', the computer program in firmware instructs the CPU (microprocessor) to obtain analog measurements. At least four analog signals: gas pressure, gas temperature, main battery voltage and case temperature, are multiplexed through the A/D converter and sent to the microprocessor for processing.

The microprocessor converts the digitized analog signals to an equivalent numeric value and stores this information in memory. Gas Pressure is stored at Item Code 008, Gas Temperature is stored at Item Code 026, Main Battery Voltage is stored at Item Code 048, and Case Temperature is stored at Item Code 031. After all measurements are obtained, the microprocessor compares the measured values to the parameter limits already in memory, i.e., pressure low limit, temperature high limit, battery low limits, etc. If any of the measured parameters are out of range, the microprocessor jumps to an alarm subroutine. Except for battery Shutdown Voltage limit exceeded, the alarm subroutine activates the appropriate alarm item code, turns on the alarm indicator and transmits an alarm pulse out the alarm channel. After the alarm sequence is complete, the microprocessor returns to its normal functions.

At the time of a full 'wake-up', if the battery Shutdown Voltage low-limit (Item Code 50) is exceeded, the microprocessor activates the alarm indicator (all seven LCD decimal points are turned-on), transmits an alarm pulse on the alarm channel, spells out the word "HELP" on the LCD. Under these conditions, the "HELP" message is displayed for as long as there is enough battery voltage to maintain the display. The Mini-Max is still correcting the gas volume, however, the user has no access until the batteries are replaced. The mechanical index is still functional. To restore normal instrument operation, remove the dead batteries and replace them with fresh ones. When the LCD goes blank, the configuration, calculated, and logged data are all safe in non-volatile memory.

After the alarm subroutine is complete, or if no alarm conditions are present, the microprocessor computes new correction factors based on the new measurements and parameters already in memory. Parameters in memory are items such as: Base Pressure, Base Temperature, Specific Gravity, etc. The new correction factors are then applied to the uncorrected volume input to obtain the corrected volume. The amount of corrected volume just calculated is then added to the totalized corrected volume stored at Item Code 000. The uncorrected volume just received is also added to the totalized uncorrected volume stored at Item Code 002.

When the microprocessor has completed the updating of its memory registers and item codes, it will update the LCD with the new corrected volume information. The microprocessor will then power down most of the main board circuits and transmit corrected volume pulses, if Item Codes 093 and 094 were configured for 'pulse outputs.' Otherwise, the main board will go back into the 'sleep' mode waiting for the next uncorrected volume input pulse.

Three other conditions can cause the Mini-Max to 'wake-up' while in the Corrector Mode. They are: a Display Button Input, a Serial Communication Link or a scheduled Audit Trail Log entry. A Display Button Input is caused by pressing the MI logo next to the LCD. It can take up to two seconds for the Mini-Max to wake up. A Display Button Input will cause the microprocessor to initiate the Meter Reader Mode. A 'wake-up' caused by a Serial Communication Link will allow the instrument to 'talk' to serial devices connected to the serial port (local or modem). An Audit Trail wake-up occurs daily. In all three cases, the microprocessor will initiate a full correction cycle as described above. Except for Audit Trail wake-ups, after the completion of the correction cycle, most main board circuits will remain energized while the instrument is performing the user requested tasks.

Drive Input

A universal mounting bracket, containing a standard digital index for indicating uncorrected volume, is used to mount the Mini-Max to a meter. A reversing gear mechanism permits changing the index rotation to match meter rotation (see Figures 2 and 3 on Page 20). Input of uncorrected volume is made by magnetically operated reed switches. A magnet is located on a disc/shaft and is rotated by the meter output shaft. There is very little torque loading on the meter. The dual input switches allow continued operation if one switch should fail. Input switch #1 is in the front and switch #2 is located in the back. If a switch failure is detected, an alarm is displayed.

Pressure System

The pressure sensing system incorporates a precision strain gage pressure transducer, located inside the Mini-Max enclosure with a ¼" NPT female case connection. A valve kit with shut-off valve, tubing, and fittings is optionally available to make the pressure connection to the meter/pipeline. A plug-in cable is used to make the connection from the pressure transducer to the main circuit board.

Temperature System

The temperature system consists of a highly stable, solid state transducer, connected to the Mini-Max through a 6-foot conductor. The probe is ¼" in diameter by 6 inches long and is provided with a slip-along fitting for the matching thermowell in the meter piping.

Supercompressibility Correction

Supercompressibility correction is included in the basic calculations if Item Code 110 is configured to “LIVE”. Specific gravity (Item Code 053), mol percent of N₂ (Item Code 054) and mol percent of CO₂ (Item Code 055) should be updated by the user so that the Mini-Max can provide accurate and continuous correction for the specified gas composition based on actual sensed pressure and temperature.

Below is a partial listing of various Mini-Max Item Codes that store correction parameters:

	Most Current	Daily Average	Previous Day Average
Gas Pressure	008	256	185
Gas Temp	026	257	186
Super (Fpv)	047	188	189

LCD Display and Scroll Function

A single 8 digit, ½” high alphanumeric display is mounted on the door of the Mini-Max and is viewable from the outside with the door closed. The LCD (Liquid Crystal Display) normally displays the corrected volume with 4, 5, 6, 7, or 8 digits. [The LCD can be configured \(at item 482\) to display any Mini-Max item.](#) The LCD is also used to indicate alarm conditions and to display the items in the Meter Reader List. All data is displayed with 2 decimal points.

Pressing the MI logo next to the LCD window allows the user to display item numbers or names followed by that item’s value. The default items are: Display Test, Totalized Uncorrected Volume, Totalized Corrected Volume, Live Pressure, Live Temperature and Battery Voltage. These items can be custom configured for up to 18 items plus live display using Mini-Max Link.

Computation Intervals

The Mini-Max’s computation interval is referred to as a ‘Full Wake-Up’. During a full wake-up, power is applied to all electronic circuits so that pressure, temperature and voltage measurements may be obtained, and a new Total Correction Factor (Item Code 043) is calculated. The LCD and volume registers are also updated. The measured parameters are compared to the alarm limits and an alarm is triggered if limits are exceeded. After completion of these tasks, the circuitry will return to the ‘Sleep’ mode and begin transmitting corrected volume pulses if Item Code 093 or 094 is set for pulse out. The full wake-up interval can be adjusted by changing the value (N) at Item Code 124 (Revs Per Wake-up). Values for N can be a number from 1 to 15, the default value is 1.

Instrument wake-up due to meter rotation other than the Nth revolution are referred to as ‘Intermediate Wake-ups’. During an intermediate wake-up, gas pressure and gas temperature are not measured and the LCD is not updated. However, the last calculated correction factors are used to update the volume registers. If the Mini-Max has been configured to output volume pulses, the pulses will be transmitted at the end of each intermediate wake-up. Since the analog circuits are not active and the LCD is not updated during an intermediate wake-up, much less battery power is used as compared to an instrument with Revs Per Wake-up equal to one (N=1).

Access Levels for Operating Personnel

There are five levels of instrument access available on the Mini-Max for operating personnel. The first level, referred to as the Corrector Mode, displays the corrected volume on the LCD and the uncorrected volume on the digital mechanical index. The Corrector Mode also provides a visual indication for instruments in an alarm condition.

The second level available is referred to as the Meter Reader Mode. Meter readers can scroll through the values of specific items on the LCD. Uncorrected and Corrected Volumes, Pressure, Temperature, Battery Voltage and any alarms that may be activated, are part of the default meter reader list. The meter reader cannot make any changes that will effect the configuration of the Mini-Max except to reset alarms.

The third level of access available is called: Level 1 Access Mode. This level of access requires an IBM compatible computer, Mini-Max Link software, an interface cable, and Level 1 Access Code. Once Level 1 Access has been gained, the operator can perform field calibration checks and make adjustments if necessary. Additionally, clearing alarms, performing certain diagnostic functions and changing the configuration of authorized items are possible.

Access at the fourth level is reserved for the instrument technician and is referred to as Level 2 Access Mode. Access to this level requires an IBM compatible computer, Mini-Max Link software, an interface cable, and the Level 2 Access Code. Once Level 2 Access is gained, the instrument technician can reconfigure Mini-Max parameters. Any and all item code values may be changed, including Level 1, Level 2, and the Instrument Access Codes. The Authorization Table may be modified, which will control what item values may be changed during Level 1 Access.

Serial Communication Mode is the last type of access to the Mini-Max. In this mode, RS-232 devices connected to the serial port can transfer data to or from the instrument. An adapter is required to convert the serial port levels to RS-232 levels. To insure data integrity, the serial communications protocol incorporates data error checking.

NOTE: Level 1 and Level 2 Access and Serial Communication Mode are computer software functions only. Even after gaining Level 1 or Level 2 Access, changes to the instrument's configuration are not possible until a valid Instrument Access Code is entered. After a serial link is obtained. Item Code and Audit Trail downloads are also possible.

The Mini-Max continues to recognize meter input pulses while in the Meter Reader, Level 1, Level 2 and Serial Communication Modes. Upon exiting any serial link access, the Mini-Max will perform a Full Wake-up just before returning to the Corrector Mode. Following a meter reader access, the instrument will return to the Corrector Mode;

- a) Without a wake-up, if there were no meter rotations during the meter reader access.
- b) After an intermediate wake-up with any number of meter rotations and N greater than one.
- c) After a full wake-up with any number of meter rotations and N equal to one.

Receiving the Mini-Max

When the instrument is delivered, be sure that all parts are received in good condition. Check the packing list to make certain the shipment is complete. Report any shortage or shipping damages to your Mercury Representative. Immediately file any damage claims with the carrier who delivered the shipment.

Function Check

Open the case door, check for any loose parts, and verify that all connectors are properly seated. The batteries are packaged separately and must be installed in the battery holder. At this time, if the Mini-Max is displaying digits on the LCD (probably all zeros) then the unit is ready for functional checks.

Note: All of the function checks assume that the instrument is configured with default parameters. The default configuration has assigned Pressure, Temperature and Volume Units, Alarm Limits,...etc. If the configuration is something other than the default, most checks can still be performed, but the results may vary slightly.

Pressure Function Check – Gauge Pressure Transducer

Press the MI button (also referred to as the display button) to scroll through the Meter Reader List and stop at the Live Pressure display. With no pressure connected, the LCD will display a value very close to zero. To check the pressure measuring system, apply some amount of pressure (but less than the full range of the transducer) and observe as the LCD value increases. There is a 30-minute time-out before the instrument automatically reverts to the Corrector Mode. Press the display button and scroll through the remaining items until the instrument returns to the Corrector Mode.

Pressure Function Check – Absolute Pressure Transducer

Press the display button to scroll through the Meter Reader List and stop at the Live Pressure display. With no pressure connected, the LCD will display a value very close to the local atmospheric pressure. To check the pressure measuring system, apply some amount of pressure (but less than the full range of the transducer) and observe as the LCD value increases. There is a 30-minute time-out before the instrument automatically reverts to the Corrector Mode. Press the display button and scroll through the remaining items until the instrument returns to the Corrector Mode.

Temperature Function

Scroll through the Meter Reader List and stop at the Live Temperature display. The LCD will display a value very close to ambient temperature – typically within plus or minus 1.0 degrees F. To check the temperature measuring system, hold the temperature probe near its tip and observe as the displayed value increases. There is a 30-minute time-out before the instrument automatically reverts to the Corrector Mode. Scroll through the remaining items until the instrument returns to the Corrector Mode.

Volume Function Check

While in the Corrector Mode, note the corrected volume reading on the LCD. Rotate the index input wriggler in one direction for ten (10) revolutions. Verify that the volume has increased by the expected amount. With zero applied pressure and at room temperature, the additional corrected volume should be essentially equal to the meter index rate, times the number of turns (10) of the wriggler. Note: the scaling of corrected volume (Item Code 090) may make it necessary to apply more than ten revolutions to see an increase at the LCD.

Standard Instrument Mounting

The Universal Mounting Bracket (UMB) permits installation of the Mini-Max on American, Rockwell, Romet, Roots or Schlumberger meters that have an instrument drive. The UMB housing may be rotated about the base plate so that the instrument and index will face in any of four (4) directions, by removing all four (4) screws which attach the base plate to the bracket housing. Replace them after you have repositioned the UMB housing.

Refer to Figure 2 and the following procedure when installing the Mini-Max on a meter.

- 1) Position the universal mounting bracket (UMB) and gasket on the meter mounting plate. Install the four (4) mounting bolts and tighten.
- 2) Connect the pressure tubing to the 1/4" NPT case pressure connector on the bottom of the instrument case.
- 3) Install the temperature probe slip-along fitting into the thermowell.
- 4) Insert the temperature probe into the slip-along fitting and tighten.

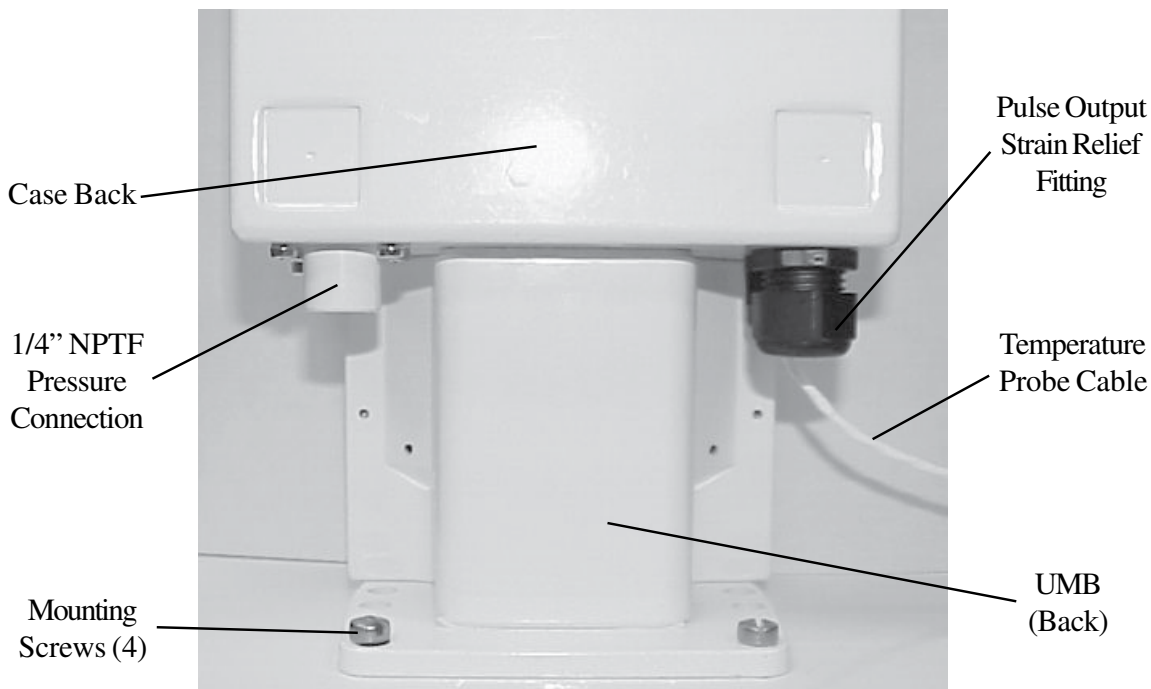

Fig. 2

Meter Rotation

A reversing gear in the Universal Mounting Bracket (UMB) permits either clockwise (CW) or counterclockwise (CCW) meter rotation to drive the Mini-Max. Before installing the Mini-Max, note whether the meter's drive rotation is CW or CCW. The Mini-Max should be configured to match the meter rotation. In order to check the instrument rotation:

- Remove the two slotted-screws holding the transparent index cover
- Remove the two (2) black thumbscrews and lift out the index. Compare the bevel gear placement with Figures 3 and 4 on Page 20 to determine if the instrument is setup to work with a CW or CCW instrument drive.

To Change Rotation, if necessary

- Use the supplied spline wrench to loosen the set screw in the lower level gear. (The spline wrench can be found inside the Mini-Max case.)
- Shift the gear down against the cross bar (CW) or up against the upper gear (CCW) in order to achieve the proper gear setting. When shifting the lower gear upward, the alignment pin in the lower gear must engage the mating hole in the upper gear.
- Tighten the set screw in the lower gear.
- Replace the index and thumbscrews. Ensure the bevel gears mesh properly with the face gear.
- Replace the transparent index cover and screws.

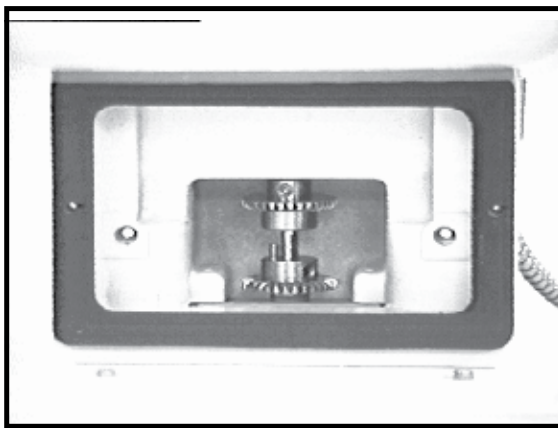

Fig. 3
Bevel Gear DOWN for CW

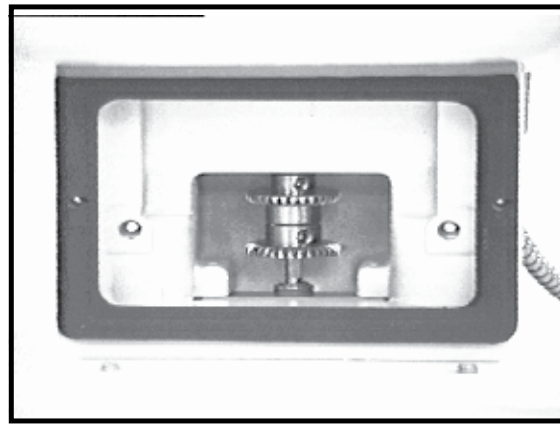

Fig. 4
Bevel Gear UP for CCW

Installing a Mini-Max without an Instrument Drive

The Mini-Max can be configured to accept low frequency meter input pulses directly from a meter or Model 210/212 pulse transmitters (or any other low frequency pulse source).

	Form-A	Dual Form-A
TB2-1	SW1 – NO	SW1 – NO
TB2-2	SW1 – COM	SW1 – COM
TB2-3	Jumper to TB2-1	SW2 – NO
TB2-4	Cable Shield**	SW2 – COM
NOTE: NO = Normally Open SW1 = Switch # 1 COM = Common SW2 = Switch # 2 TB2 = Terminal Block # 2 *For Form C switches, wire only the normally open switch. **Connect the Cable Shield only at one end		

Table 1
Wiring Connections for RSI Board

The Mini-Max microprocessor has an internal counter connected to the meter pulse input. The number of input pulses per count is stored in the Meter Scaling Item Code (114).

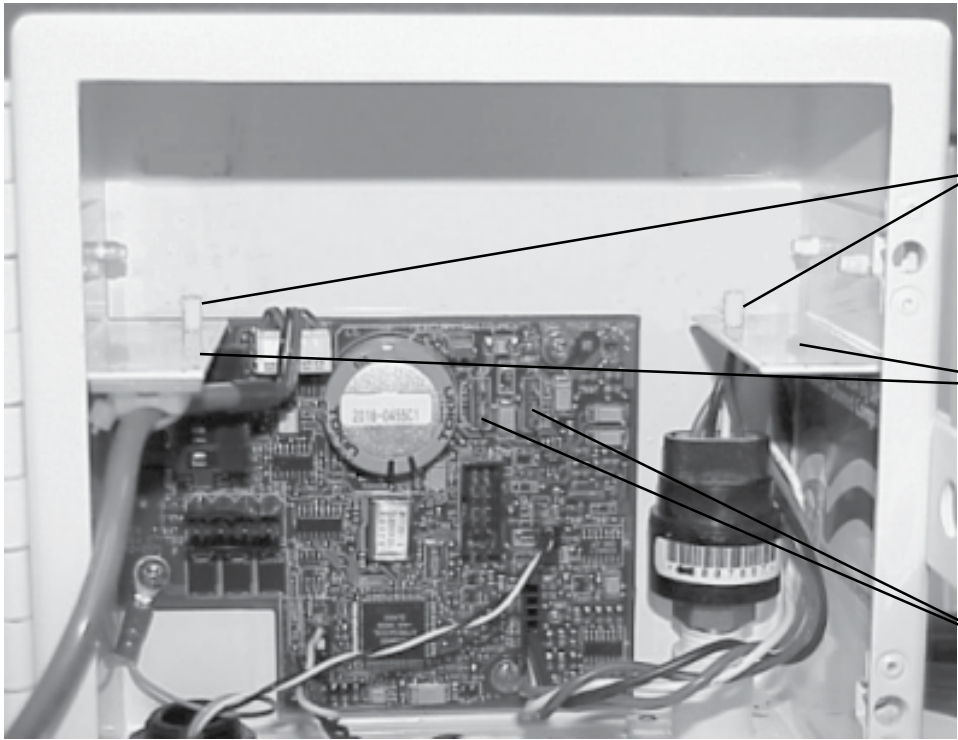

Fig. 5
Battery Location

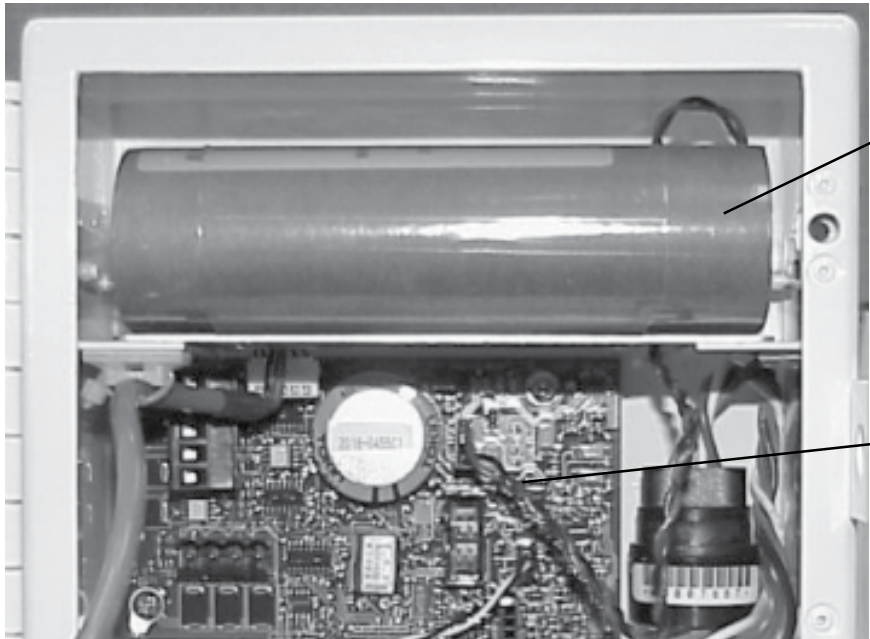

Fig. 6
Battery in
place

Installing or Changing Battery Packs

The standard power supply for the Mini-Max is an alkaline receptacle pack (40-2595) with four replaceable D-cell batteries. The battery pack is mounted above the printed circuit board (see Figs. 5, 6 on Page 22). The expected service life of the battery pack is greater than four (4) years under normal use, with considerable reserve to allow for battery replacement after the low battery alarm occurs. If the battery voltage drops below a preset value, a BATTERY LOW alarm occurs. When this alarm occurs, the batteries should be replaced as soon as possible.

One optional power supply is available for the Mini-Max: a disposable alkaline pack (40-2596).

Basic operation is continued while the battery pack is being changed. Meter pulses will be accumulated for up to half an hour while the battery pack is disconnected. Other functions, such as display, serial communication, volume calculation, and, alarms are not available during this time.

To Install Batteries in Alkaline Receptacle Pack

- Open the front door
- Remove the battery pack by lifting the back and sliding forward
- Unplug the battery cable from the printed circuit board (J3)
- Open the cover by pulling on the Velcro tab underneath
- Replace or install four D-cell alkaline batteries, making sure to orient each cell for proper polarity
- Close the cover over the battery pack
- Plug the battery cable back into J3
- Place the battery pack on the rails above the printed circuit board. Raise the back of the pack to slide over the pins on the rails. Make sure the pins fit into the holes in the battery pack.

Super Cap

The Super Cap is a capacitor that acts as a memory battery in the Mini-Max. While power is applied from the main battery the super cap will charge. When the battery is unplugged the super cap takes over the job of supplying power to the Mini-Max. The super cap will supply power for approximately thirty minutes after the battery is disconnected.

Battery Status Information

As the battery begins to discharge, the operation of the Mini-Max will change. Refer to Table 2 on Page 23 for information regarding various power modes of the Mini-Max.

Power Mode	Battery Voltage Range	Control of Upper Limit	Typical Duration	Notes
Normal	6.2- 4.3		4+ years	Normal operation
Low Battery Alarm Mode	4.3- 4.0	Item 049	2 months	Low Battery Alarm set. Still in normal operation
Help Mode	4.0- 3.8	Item 050	1 month	HELP is displayed instead of corrected volume. Low Battery Alarm is still set. Still operating normally. Instrument will not leave this mode until voltage reading is above 4.8 volts
Conservation Mode	3.8- 2.93	Hard- coded in firmware at 3.8 volts	?- no guarantee	Instrument is only counting input pulses and keeping time. All other operations are suspended. The display is blank. All process items are saved to EEPROM.
Low Voltage Reset	2.93- 0.0	Set in hardware at 2.93 volts		Voltage detector holds down the processor reset line. Instrument does nothing.
Super Cap Backup	0.0	Digital input (Battery Removal)	30 minutes (or less if in conservation mode)	Same as Conservation mode except that the instrument wakes up every 8 seconds to check battery voltage.
Shutdown		Software command		Induced by user for storage or shipment. All normal operation ceases and item log data are saved to EEPROM

Table 2
Battery Modes

The Mini-Max was setup according to our company's specifications and was shipped from the factory without any batteries installed. The configuration information was programmed into E²PROM, which can maintain its memory without any power applied to the instrument. However, the batteries must be installed into the instrument before being placed into service. After the batteries are initially installed, the display will not be visible for about 20 seconds.

The Mini-Max is now fully powered. A low voltage battery alarm, Item Code 099, will occur when the main battery runs low on power. The battery alarm set point (BATTERYLOLMV Item Code 049) is calculated to give two months notice to the user to replace the battery. This is a safety margin. This amount of time will vary depending on outside air temperature, number of wake-ups and several other factors. Under normal conditions, replace the batteries as soon as the battery alarm is displayed. When the SHUTDOWN VOLTAGE, Item Code 050 is reached, HELP will be displayed on the LCD. The instrument will still function normally, with the exception that the corrected volume will not be displayed. After about another month, when the instrument voltage drops below a critical level, the LCD and serial communications will be disabled to conserve power. Uncorrected pulses will continue to be accumulated, but no volume correction will take place. To see the Corrected Volume and the Audit Trail, the batteries will have to be replaced. If the batteries are still not replaced, all historical data in non-volatile memory, configuration, and firmware will still be intact, but volume pulses input after this time will be lost.

Serial Connector

The Mini-Max's serial connector permits data transfer to or from the on-board memory of the instrument. Any RS-232 serial device can be connected to the instrument's serial port via the MPA (P/N 40-2620) or [Mini-Max I/O cable \(P/N 40-2696\)](#), but the serial device must be able to communicate using Mercury's serial data protocol.

Warning: Connecting the MPA only permitted in a non-hazardous location.

Modem operations, as well as local serial connections; are supported by MasterLink32 and Mini-Max Link software. All other third party software and RS-232 devices (such as Automatic Meter Reader equipment) require Mercury Serial Data Protocol to be incorporated into the communication drivers.

Refer to Figure 7 below when making connections to the local RS-232 serial port. The MPA (p/n 40-2620) incorporates a serial data voltage adapter. Place the rectangular socket on J5 and push the connector into the port as far as it will go. Locate the serial port on the laptop computer (it may be labeled COM1, COM2, RS-232 or just Serial). Connect the I/O cable DB-9 connector to the laptop computer serial port and connect the round connectors from the MPA and I/O cable together. The Mini-Max Link Software Manual and help screens contain information about operating Mini-Max Link software.

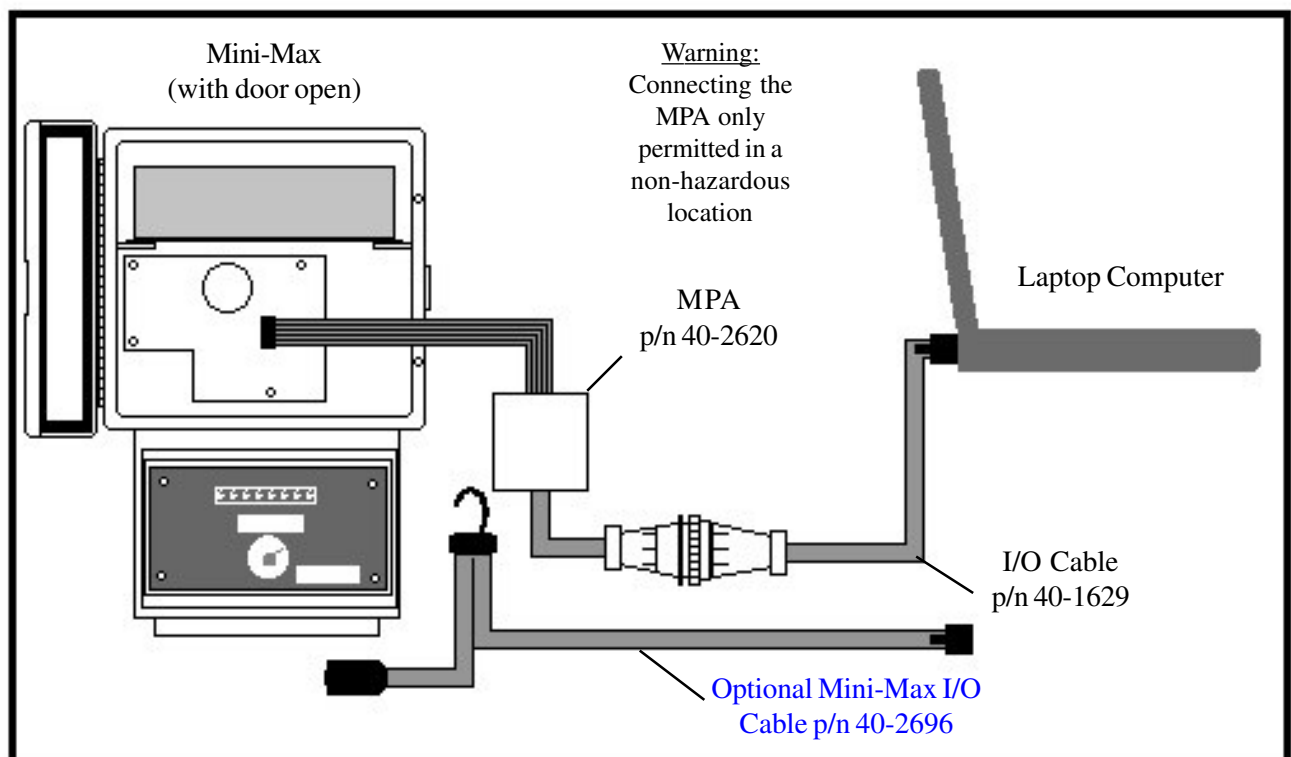

Fig. 7
Serial Connection to Mini-Max

LCD Diagnostic Function (Linking)

Beginning with firmware version 2.4013, the Mini-Max will display additional characters on the LCD to let the user know the status of the serial link. Examples are below.

<u>Display</u>	<u>Description</u>
vvvvvvv	Normal numeric display when not linked (default is corrected volume total)
LINKING	Instrument has awakened due to serial activity.
AUTOBAUD	Instrument has awakened due to serial activity and item 126 is set to AutoBaud.
LLbbbccc	Instrument is attempting to link. bbb is the instrument baud rate and ccc are the protocol characters received when the baud rates of the Mini-Max and computer match.
LLvvvvvv	Instrument is linked, 'vvvvvv' is the last six digits of normal display

Serial I/O Board (Optional)

There is an optional Serial I/O board (p/n 40-2717) available for the Mini-Max. This board is a CMOS to RS-232 converter and enables the use of an external case connector and/or RS-232 modem. The Serial I/O board plugs into the Mini-Max main board at connector J5 and is mounted on the board via a standoff and screw. There are 3 versions of the serial I/O Board, listed below.

<u>Part Number</u>	<u>Description (and use)</u>
40-2717	Standard Serial I/O board with external case connector (Used to connect the standard serial cable (40-1629) to the Mini-Max.)
40-2717-2	Standard Serial I/O board modified with a terminal block to connect RS-232 wires. (Used for connecting an external or internal RS-232 modem to the Mini-Max without a case connector)
40-2717-3	Standard Serial I/O board with external case connector and shorting plug. (Used for the instrument configuration where both an external case connector and internal modem is desired.)

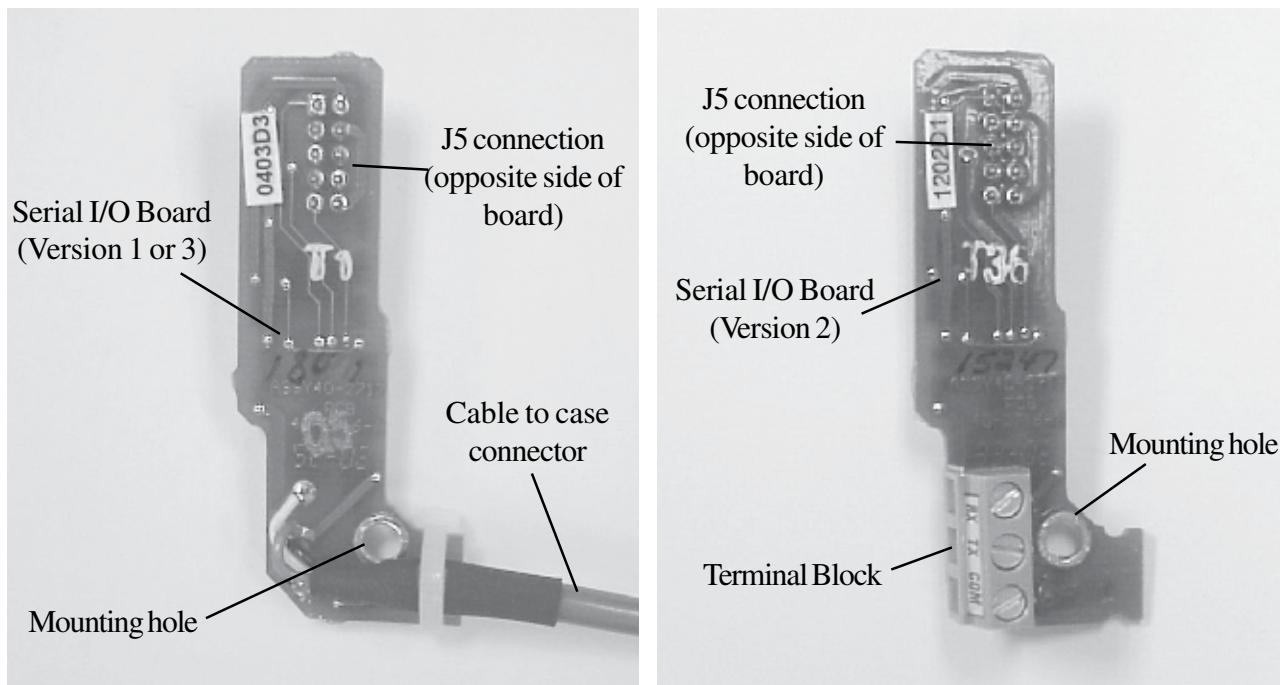

Fig. 8
Serial I/O Board comparison

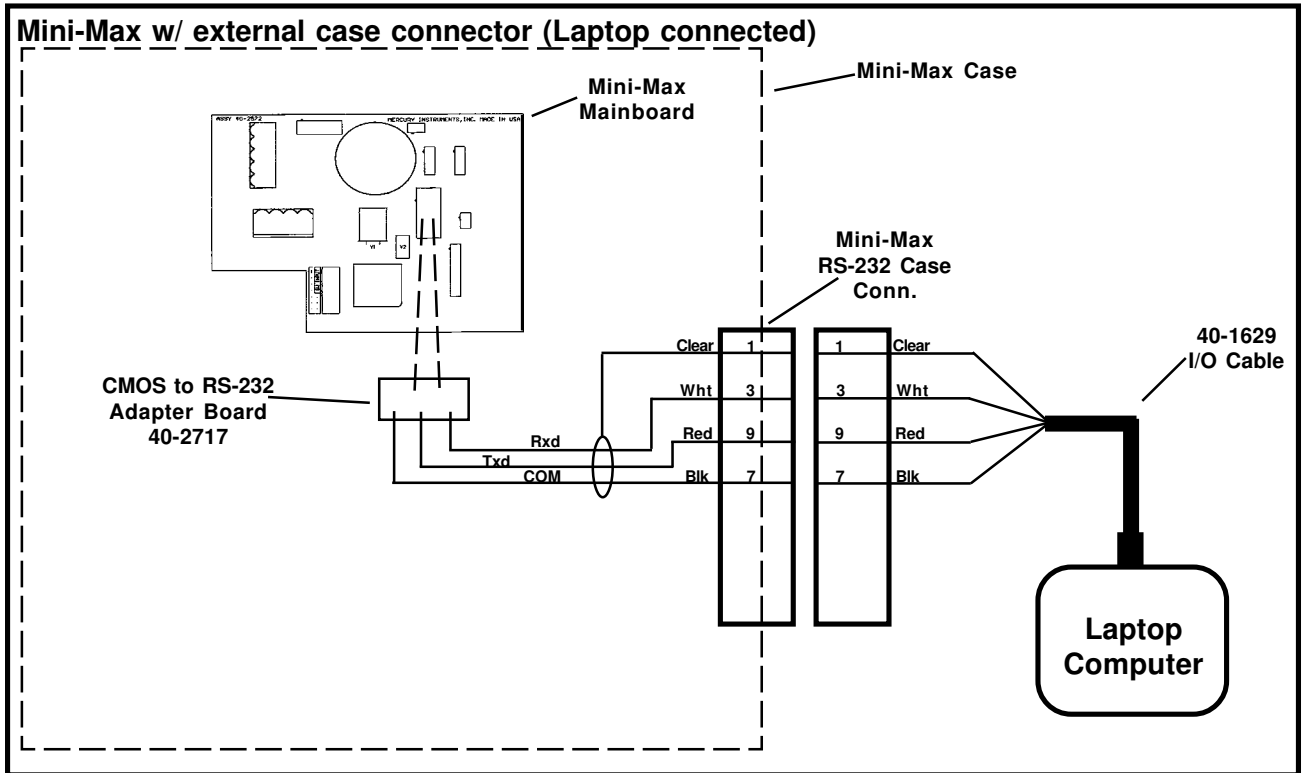

Fig. 9
Mini-Max w/external case connector

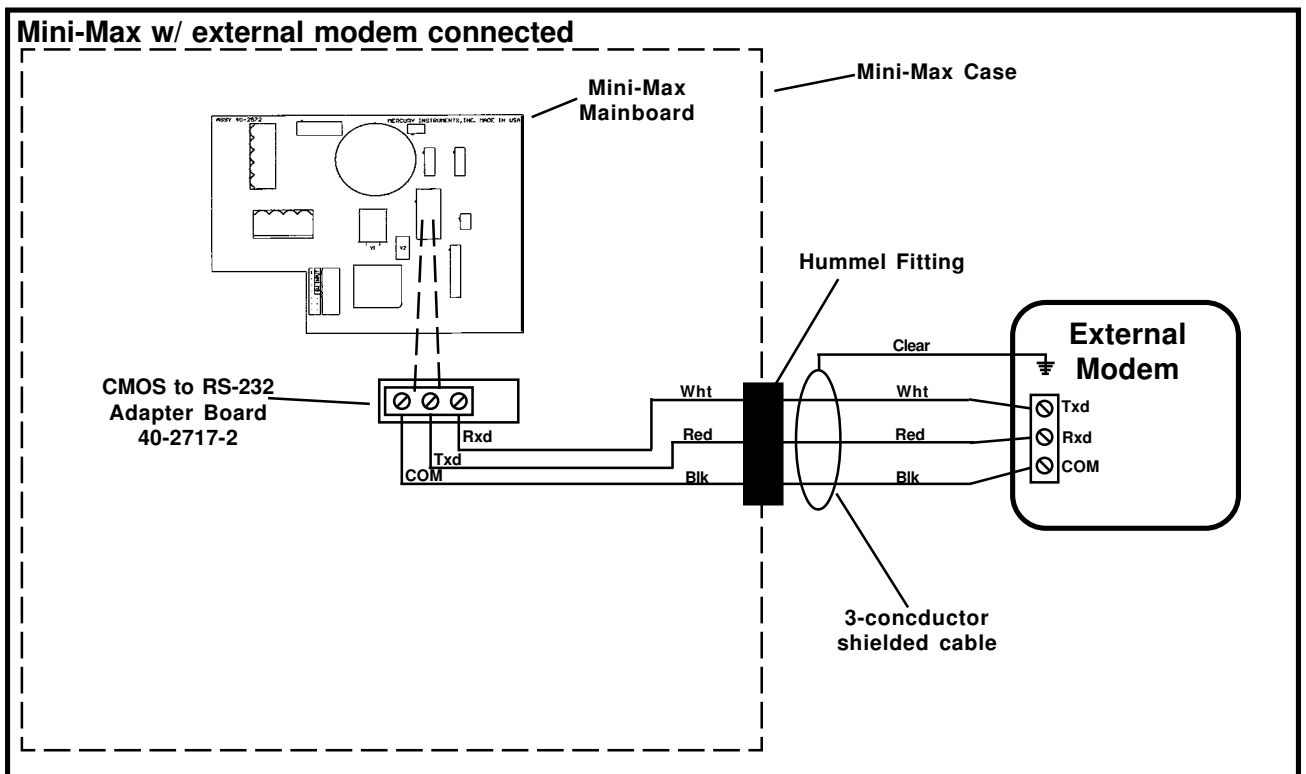

Fig. 10
Mini-Max w/external modem

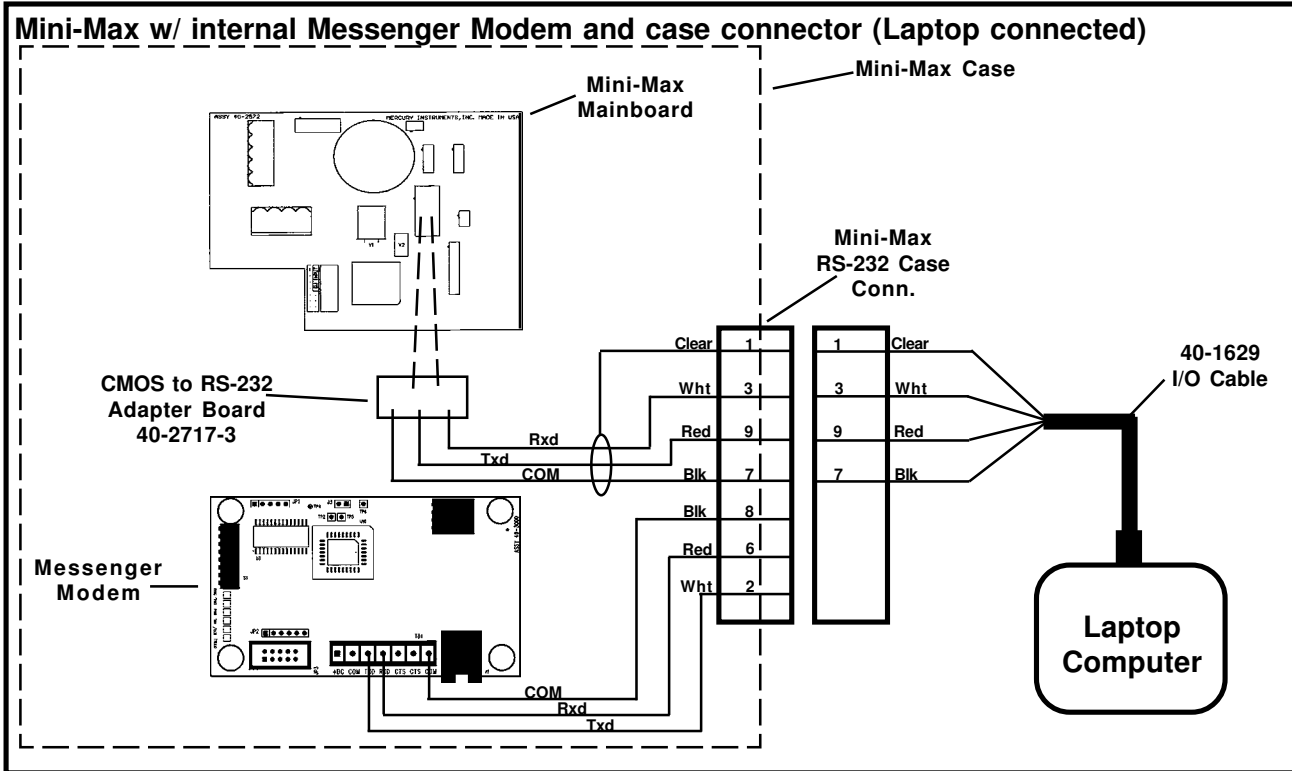

Fig. 11

Mini-Max w/internal messenger modem and case connector

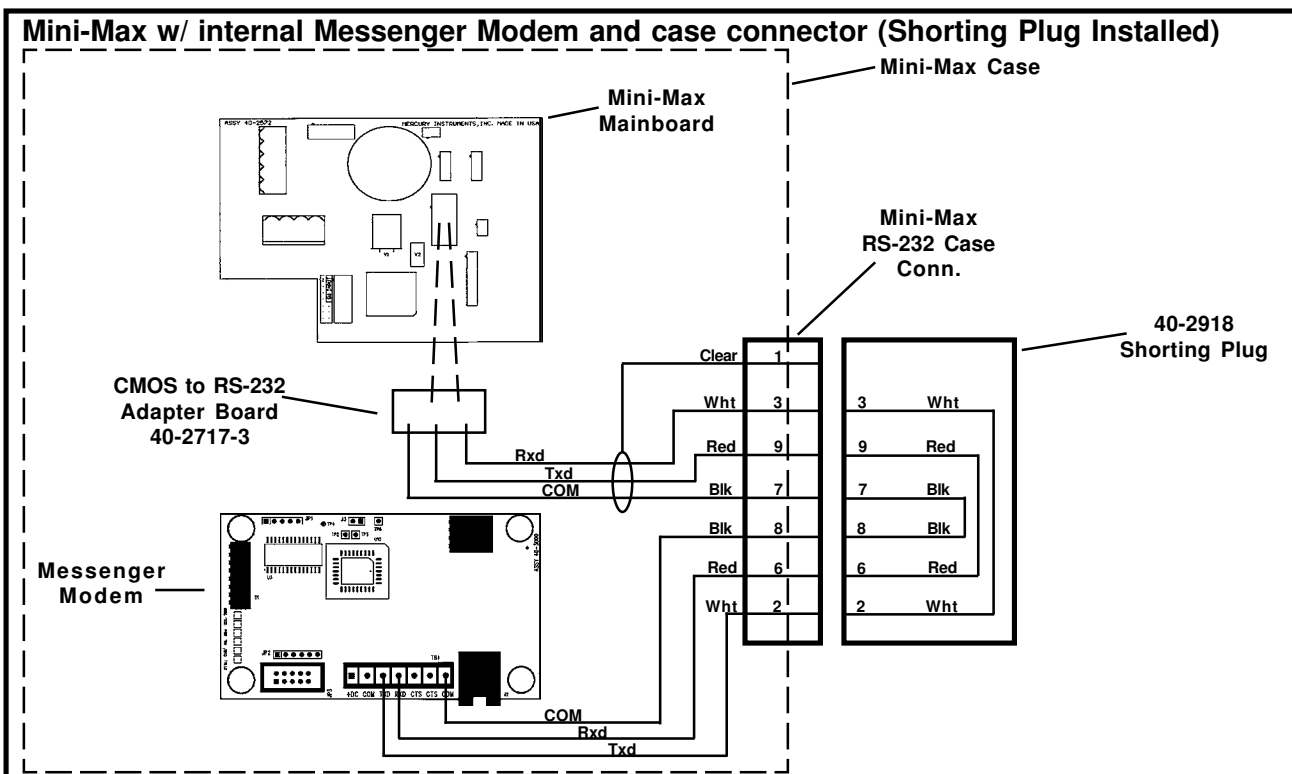

Fig. 12

Mini-Max w/internal messenger modem and case connector (shorting plug installed)



Fig. 13
Shorting Plug installed

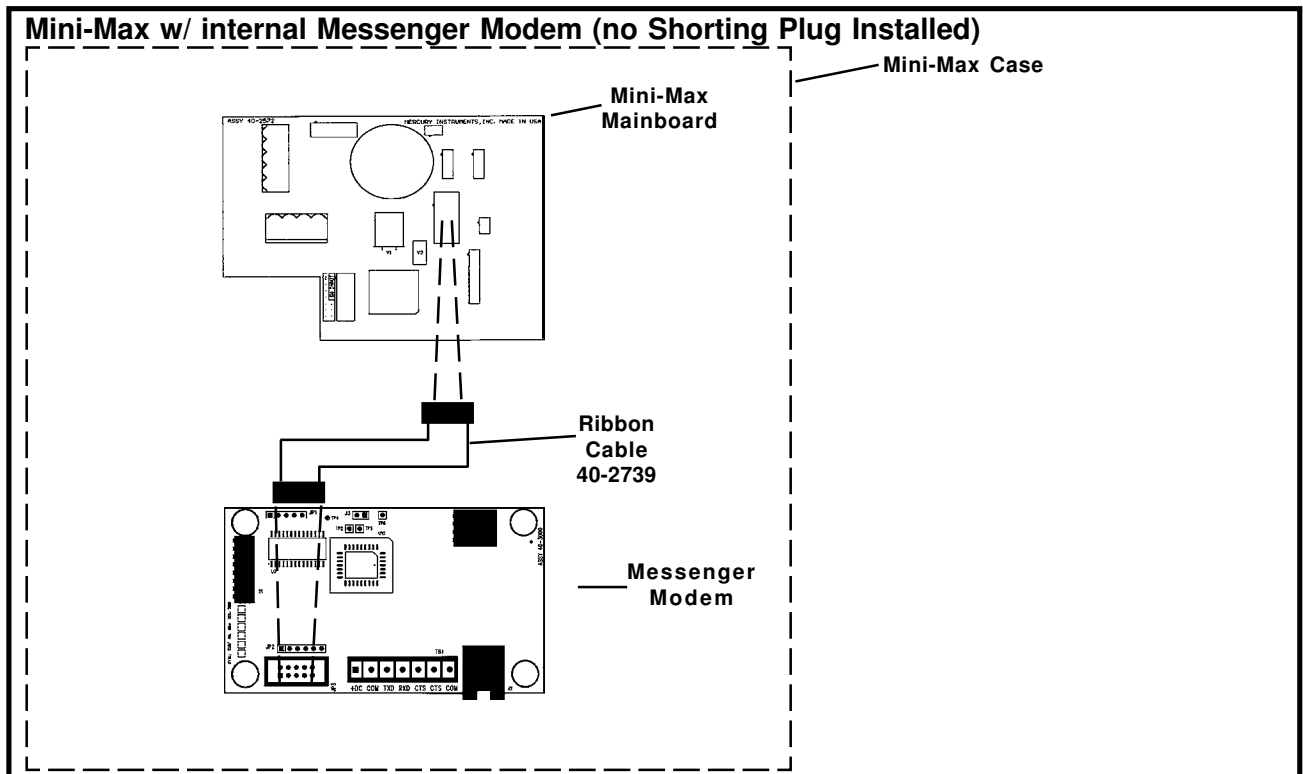

Fig. 14
Mini-Max w/internal messenger (no case connector)

Communicating to the Mini-Max with a Modem

The Mini-Max has one serial port. The serial connection can be used for local connections and for modem connections. The baud rate can be set manually using MasterLink32 or automatically set by the Mini-Max firmware if the Autobaud feature is enable.

The Mini-Max can be connected to a modem through the MPA. However this method will cause the battery life to be decreased significantly. A low power modem, the Mercury Messenger Modem can be installed in the Mini-Max. The Messenger Modem will connect directly into the Mini-Max's serial connection port (J5) [via ribbon cable or serial I/O board](#).

Automatic Call-In Feature

The Mini-Max has the capability to initiate a modem-to-modem telephone call. This can happen under two circumstances. The first of these is an Alarm Call-In, and the second is a Scheduled Call-In.

The Alarm Call-in feature can be configured to call in one of two ways. The first is by using an alarm pulse to trigger the automatic call-in feature of a Mercury Modem. When an alarm condition is detected, the Mini-Max will generate an alarm pulse. The Alarm Call-In feature is designed to be used with Mercury Instruments Alarm-Link Software only.

To use this method, set the following items:

333	Call-in Trigger	1 - Alarm Call-in only
484	Alarm Channel Control	0 - Alarm Pulse Output
486	Modem AT Enable	0 - Call-in via Alarm Pulse

Note: The Mercury Modem has to be configured properly to use this method. Refer to the Installation Guide for the Mercury Modem for more information.

The second Alarm Call-In method is accomplished by sending Hayes AT-type commands out the serial port to a generic-type modem, such as the Messenger Modem. In this method, the Mini-Max firmware takes control of all call-related functions including call retry.

To use this method, set the following items:

333	Call-in Trigger	1 - Alarm Call-in Only
486	Modem AT Enable	1 - Call-in via AT commands
491	Modem Init String	Initialization command of the modem Default = &F
492	Modem Dial String	Command sent to initiate dialing Default = ATDT
493	Alarm Call-In Phone #	Phone number to call for alarm
494	Modem Hang-up String	Command sent to modem for hang-up Default = ATH
495	Modem Retry Interval A	Time (in minutes) between short-term retries Default = 5
496	Modem Retry Interval B	Time (in minutes) to wait before trying again if all short-term retries fail Default = 1440
497	Modem Retry Count A	Number of short-term retries

The Scheduled Call-In feature also requires the Mini-Max to issue AT commands to a Messenger Modem. This feature is designed to interface with third party software applications that can accept a scheduled call-in from a remote site.

To use this method, set the following items:

333	Call-in Trigger	2 - Scheduled Call-in only
334	Scheduled Call-in date	desired date of call
335	Scheduled Call-in time	desired time of call
339	Scheduled Call-In Phone#	Phone number to call at scheduled time
486	Modem AT Enable	1 - Call-in via AT commands
491	Modem Init String	Initialization command of the modem Default = &F
492	Modem Dial String	Command sent to initiate dialing Default = ATDT
494	Modem Hang-up String	Command sent to modem for hang-up Default = ATH
495	Modem Retry Interval A	Time (in minutes) between short-term retries Default = 5
496	Modem Retry Interval B	Time (in minutes) to wait before trying again if all short-term retries fail Default = 1440
497	Modem Retry Count A	Number of short-term retries

Note: After each Scheduled Call-in, the date in item 334 must be changed to reflect the next desired call-in date. Otherwise the instrument will not call-in again.

The Mini-Max can also be configured to call in for both the scheduled and alarm case. In order to configure the instrument for this method the following items must be set:

333	Call-In Trigger	3 - Alarm & Scheduled Call-in
334	Scheduled Call-in date	desired date of call
335	Scheduled Call-in time	desired time of call
339	Scheduled Call-In Phone#	Phone number to call at scheduled time
486	Modem AT Enable	1 - Call-in via AT commands
491	Modem Init String	Initialization command of the modem Default = &F
492	Modem Dial String	Command sent to initiate dialing Default = ATDT
493	Alarm Call-In Phone #	Phone number to call for alarm
494	Modem Hang-up String	Command sent to modem for hang-up Default = ATH
495	Modem Retry Interval A	Time (in minutes) between short-term retries Default = 5
496	Modem Retry Interval B	Time (in minutes) to wait before trying again if all short-term retries fail Default = 1440
497	Modem Retry Count A	Number of short-term retries

In this case, Item 338 (Scheduled Call-In Occurred) may be used by the host system to determine whether the call-in was triggered by an alarm or was a scheduled call. For a scheduled call-in, this item will be set to '1'. To use this feature, the host system must reset the item to '0' after reading a '1'.

Modem Power Control

The Mini-Max has the ability to use the Alarm Pulse channel on TB1 to control the power to an external device such as a modem or cellular phone. To enable this feature, set Item 484 (Alarm Channel Control) to Modem Power Control. When Modem Power Control is enabled, the alarm channel acts as a power switch during user-specified times. For a call-in (Alarm or Scheduled), Item 487 specifies the number of minutes to leave the system powered up immediately after the call-in is complete (thus allowing the host to call back if necessary). The Alarm Channel can also be set to power the modem during a specified interval in which a host may call out to the instrument. The time structure for call-out is set by Items 485, 488, 489 and 490. See the diagram below for an explanation of how to set the appropriate items.

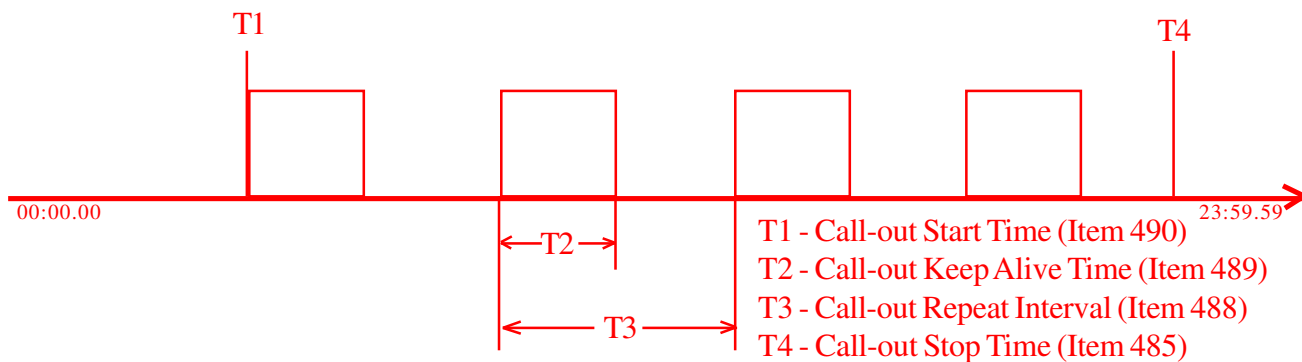

Example: Suppose that the desired call window is at the top of every other hour during the day. Also suppose that the maximum time to power the modem is 15 minutes. For this configuration, Item 490 (T1) will be set to 09 00 00, Item 485 (T4) will be set to 15 15 00, Item 489 (T2) will be set to 15 and Item 488 (T3) will be set to 120.

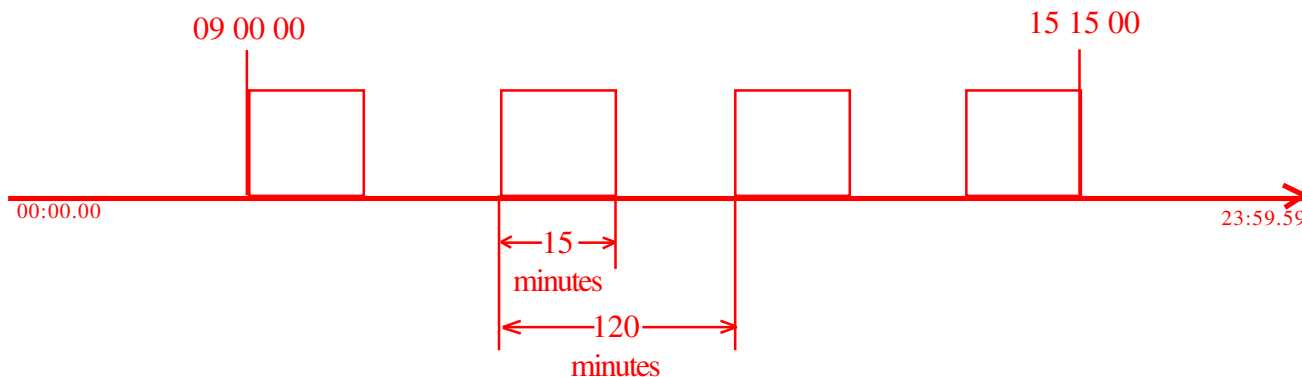

Alarms

The LCD will display decimal points between each numerical digit when the instrument has recognized an alarm. If the Default Display (item 482) is set to an item containing a decimal point (e.g. Instantaneous Flow Rate, item 209), then the decimal point position will be blank when the instrument is in alarm mode. An optional text message, entered into item 483 (limited to 8 characters), can be displayed. The alarm text message toggles between the normal display (usually corrected volume) every eight seconds.

Examples:

LCDs without Alarms

0 0 0 4 5 6 7 8

CorVol display
(no alarms)

1 8 1.3 4

Flow Rate display
(no alarms, notice decimal point)

LCDs with Alarms

0.0.0.4.5.6.7.8

CorVol display
(with alarm)

. . .1.8.1 3.4

Flow Rate display
(with alarms, notice missing decimal point)

A L A R M

Alarm Text display

Press the MI logo to activate the display list. This displays the first alarm code on the LCD. Continue scrolling with the display button to display additional alarms, if they exist. After displaying the last alarm code, continual use of the button will cause the normal Meter Reader List to be displayed on the LCD. Table 3 below is a listing of all alarms currently available from the Mini-Max.

Alarm Description	Item Code	E Code	Version 1.00	Version 2.40
Main Battery Low	099	.E.0.9.9.	X	X
Index SW #1 Fault	102	.E.1.0.2.	X	X
Index SW #2 Fault	103	.E.1.0.3.	X	X
A/D Fault	104	.E.1.0.4.	X	X
Pressure Low	143	.E.1.4.3.	X	X
Temperature Low	144	.E.1.4.4.	X	X
Pressure High	145	.E.1.4.5.	X	X
Temperature High	146	.E.1.4.6.	X	X
Daily CorVol	222	.E.2.2.2.	X	X
REI Alarm	435	.E.4.3.5.		X
Replace Main Battery ("Shutdown")	.H.E.L.P.	.H.E.L.P.	X	X

Table 3
MINI-MAX Alarm Codes

Clearing Alarms

The Mini-Max is designed to allow manual clearing of alarms using the MI push button. To clear all instrument alarms, scroll through the alarm codes until the LCD displays “E.E.E.E.E.E.E”, then simply allow the display to time-out, which takes about 1-minute. After the “E.E.E.E.E.E.E” display has timed-out, the LCD will display the first item of the Meter Reader List, usually the Display Test, “8.8.8.8.8.8.8”. This will happen only if Item 128 (Mag Alarm Acknowledge) is enabled. If it is disabled “E.E.E.E.E.E.E” will not be displayed, and the alarms cannot be cleared using the display button. Additionally, alarms may be cleared using the “Display and Clear Alarms” function in the Mini-Max Link or MasterLink software.

HELP Mode

When the Battery Voltage (Item 048) drops below the Shutdown Voltage (Item 050 usually 4.00 volts), the instrument enters shutdown (HELP) mode. In this mode the LCD will display “.H.E.L.P.” to signify that the battery voltage has reached a critical level. The batteries should be replaced immediately when the instrument is in shutdown mode. After the replacing the batteries, if the voltage is above 4.8 volts, a push button input, or serial access will wake-up the instrument. This will allow the Mini-Max to function normally again. See Table 2 on page 24 for more info on instrument power modes

Alarm Recording

The Date and Time of all Mini-Max alarms are recorded as Item Codes. When an alarm occurs the Date and Time Item Code will be updated. The alarm condition, Time and Date stamps are latched in to Mini-Max memory. Multiple triggering of the alarm will not change the alarm status or Time and Date stamps. If the alarm condition disappears and then returns, a new time and date stamp will not be entered. When the alarm is cleared, the Time and Date stamp will remain so that a record of the last acknowledged alarm will be present. When a new alarm occurs, new Time and Date stamps will be entered into the appropriate Item Codes. The exception to latched alarms is the Battery Alarm. It is automatically cleared when the batteries are replaced. Clearing all the alarms will also clear the dots on the LCD (or “ALARM” text).

Alarm Pulse Outputs

The Mini-Max will generate a Form-A, 100 millisecond wide pulse on every new alarm. The alarm pulse is available at terminals A- and A+ of TB1. Item Code 108 (Alarms Output) will be logic ‘High’ (1111111) to indicate an alarm pulse has been transmitted.

Pulse Outputs

As a standard feature, the Mini-Max provides three Form-A pulse outputs. The outputs are electronic switches that operate much like an 'open collector' transistor. All Mini-Max electronic pulse outputs, including the alarm pulse, incorporate opto-isolators to isolate the Mini-Max circuitry from the devices receiving the pulses. The first two pulse outputs may be configured as either Corrected Volume or Uncorrected Volume. The third output pulse is for alarm output only.

The Uncorrected Volume pulse is derived from reed switches mounted on the input pulse board. As the magnet disc rotates past them on each meter revolution, a pulse is sent to the Mini-Max main board. The value of the pulse is determined by the Meter Index Code (Item 98) and the Meter Scaling Factor (Item 114). The value is then converted to the units set in Item 92, UncVol Units Code, and output to the pulser. Generally, each output pulse represents the amount of uncorrected gas flow during a single meter revolution. The Corrected Volume pulse output is the calculated value of the Uncorrected Volume adjusted for temperature, pressure and supercompressibility. Use MasterLink32 software to select the pulse type at Item Codes 093 and 094.

By default, the Mini-Max is configured for a pulse width of 62.5 milliseconds, having a period of 125 milliseconds. Other pulse width durations are available by changing Item Code 115.

Output Pulse Specifications

- 1) All outputs are isolated from ground and each other.
- 2) Outputs are rated for DC only, from 3.0 volts to 30.0 volts. Observe polarity.
- 3) The volume pulser and alarm circuits will sink up to 5 milliamperes (DC).

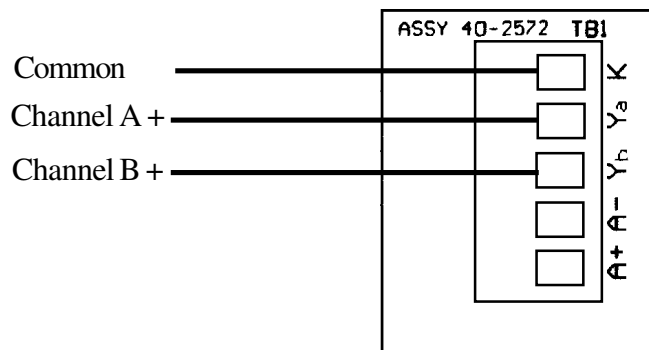

Figure 15
Mini-Max Pulse Output Connections
(upper left corner of Mini-Max board)

The pulse width and period can be varied by the selection of Item Code 115. The period is set to twice the pulse width. For example, a 0.0625 second pulse will have a total cycle time of .125 seconds.

- Select: 0 – 0.0625 Sec. (Default)
 1 – 0.5000 Sec.
 2 – 1.0000 Sec.
 3 – 0.1250 Sec.
 4 – 0.2500 Sec.

Value at Item Code 115		Form-A		
		Pulse Off Sec.	Pulse Cycle Sec.	Max Pulse Repetition Rate, CPS
Code	(Sec.)			
0	0.0625	0.0625	0.1250	8
1	0.5000	0.5000	1.0000	1
2	1.0000	1.0000	2.0000	0.5
3	0.1250	0.1250	0.2500	4
4	0.2500	0.2500	0.5000	2

Table 4
Output Pulse Codes

The pulse timing chart on this page compares the relationship of Pulse Width, Pulse Cycle, Pulse Off Time and Pulse Repetition Rate.

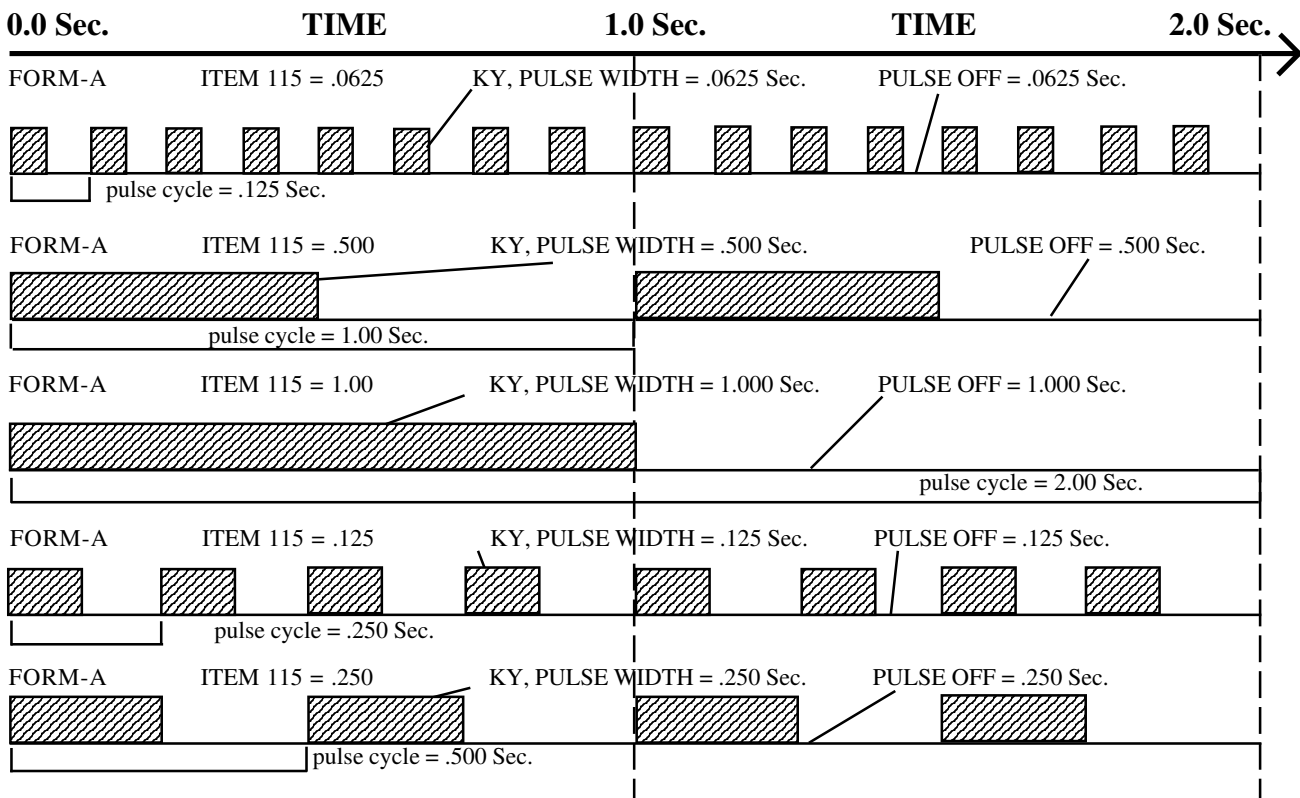

Digi-Span Fuel Switching Feature

A Mini-Max connected to a Digi-Span module provides an automatic or manual fuel switching function when Item 340 is enabled. This feature requires Mini-Max's Pulser-A output to be connected to the Digi-Span's "Gas Override" terminal, the Pulser-B output connected to the "Oil Override" terminal, and the common terminal 'K' connected to the Digi-Span common. When Item Code 340 is configured for Automatic mode, a pre-selected temperature at the Digi-Span module determines which fuel is 'switched on'. Item 340 may also be configured for either a manual "Gas Override" or a manual "Oil Override", which results in a continuous ON at one of the pulse outputs channels.

Although not an original design consideration, there may be other applications that could make use of a continuous ON from either pulse output channel besides the Digi-Span module. Care must be taken to be certain that the connected device can be actuated with 5 mA of current, or less. Regardless of the connected device, enabling item 340 places a heavier burden on the battery which will decrease battery life.

Mini-Max Operating Modes

While in service, the Mini-Max is always in one of five operating modes. The operation of the instrument in each state is well defined and suited to a particular purpose. The five states are referred to as “Operating Modes” and are:

1. Corrector Mode
2. Meter Reader Mode
3. Level 1 Access Mode
4. Level 2 Access Mode
5. Serial Mode

In all five Modes, the Mini-Max may be receiving and processing uncorrected volume, pressure and the temperature inputs. In the Level 2 Access Mode, the Mini-Max would normally be on the bench in the meter shop or instrument shop.

Corrector Mode

The Mini-Max normally operates in the Corrector Mode. The other four modes always return to the Corrector Mode when completed. The corrected volume continuously appears on the LCD display while the uncorrected volume is displayed on the mechanical index in the mounting bracket.

Uncorrected volume pulses are detected by magnetically actuated reed switches at each meter revolution or by pulses from a remote sensor. The instrument electronics are normally in a standby (sleep) mode, but are activated (full wake-up) by an input pulse. The number of revolutions required for a full wake up is determined by Item 124. During a full wake-up, the instrument measures the gas pressure and temperature, then calculates the correction factors and updates the corrected volume on the display. The electronic circuitry returns to the sleep mode to conserve battery power until the next full wake-up.

Meter Reader Mode

This mode provides the meter reader the ability to view instrument item values in addition to the corrected volume without opening the door. By pushing the “MI” button on the left edge of the display window, the meter reader can scroll through a sequence of readings.

At the time the meter reader activates the unit with the first display button input, the display will step through each item with every display button input and return to the Corrector Mode after the last item is displayed. After a one minute time-out for non-live displays or a 30 minute time-out on Live Pressure and Live Temperature, the unit will automatically return to the Corrector mode. Input pulses that accumulated while in Meter Reader Mode will be processed just prior to returning to Corrector Mode.

Level 1 Access Mode

Level 1 Access is considered a lower level access to instrument functions and is gained through the use of a laptop computer. Level 1 Access is a software function using the instrument's companion software, Mini-Max Link, but requires the instrument to be connected to the computer's RS-232 serial port. The user must enter a valid five digit access code at the computer's keyboard to gain software access, the default code is: "11111". (See Mini-Max Link SOFTWARE USER'S Guide for additional information on using Mini-Max Link functions.)

Level 1 Access permits instrument calibration for pressure and temperature. A limited number of parameters may be displayed and changed if authorized. Also, if authorized, Audit Trail downloads, Alarm viewing and Alarm clearing are possible. When attempting to establish a serial link to the instrument, the software may request the user to input a five-digit Instrument Access Code. This access code is necessary to maintain instrument security. The default Instrument Access Code is: "33333". This access code may be changed if desired, but requires Level 2 Access.

While the instrument is in Level 1 Access, the unit keeps track of incoming uncorrected pulses. Corrected and uncorrected totals are updated when exiting Level 1 Access, using values of pressure and temperature measured just before exiting. The pressures and temperatures applied during any calibration process are not used for any of the correction calculations.

NOTE: Be sure line pressure and temperature are restored before exiting Level 1 Access, otherwise improper correction factors will be applied to any stored input pulses.

Level 2 Access Mode

The Level 2 Access Mode allows the factory or the user to configure the Mini-Max instrument. Level 2 Access is considered a higher level access to all instrument functions and is gained through the use of a laptop computer. Level 2 Access is also a software function using the instrument's companion software, Mini-Max Link. The user must enter a five-digit access code (default: "22222") at the computer's keyboard. (See Mini-Max Link SOFTWARE USER'S Guide for additional information on using Mini-Max Link functions.)

Level 2 Access permits instrument calibration and configuration. Any instrument parameter may be displayed and changed. When attempting to establish a serial link to the Instrument, the software may request the user to input a five-digit Instrument Access Code. This access code is necessary to maintain instrument security. The default Instrument Access Code is: "33333". This access code may be changed, if desired, when the user is at Level 2 Access.

While the instrument is in Level 2 Access, the unit keeps track of incoming uncorrected pulses. Corrected and uncorrected totals are updated when exiting Level 2 Access, using values of pressure and temperature measured just before exiting. The pressures and temperatures applied during any calibration process are not used for any of the correction calculations.

NOTE: Be sure line pressure and temperature are restored before exiting Level 2 Access, otherwise improper correction factors will be applied to any stored input pulses.

Serial Mode

The Mini-Max's Serial Mode permits data transfer to and from the on-board memory of the instrument. The Mini-Max serial port operates at CMOS levels, but any RS-232 serial device can be connected using the MPA adapter. The serial device must be able to communicate using Mercury's serial data protocol. The transmission of output volume pulses is suspended while in this mode. Input volume pulses will continue to be counted.

A low power modem may be installed in the Mini-Max enclosure and share power from the main battery. Modems are generally used to transfer data (Audit Trail) from a remote location to a host computer. All serial devices require Mercury's Serial Protocol in the communication driver.

Meter Reader Mode (Detailed Description)

During normal operation, the Mini-Max is operating in the Corrector Mode. To obtain information in addition to corrected and uncorrected volume, you may access the instruments' Meter Reader Mode by pushing the MI logo next to the LCD window. The Meter Reader Mode provides the ability to display items on the LCD display without opening the instrument door. The default items that can be viewed are:

- Alarms
- Display Test
- Uncorrected Volume
- Corrected Volume
- Live Pressure
- Live Temperature
- Battery Voltage

Gaining Access to Meter Reader Mode

To gain access to the Meter Reader Mode, push the MI logo next to the LCD window, see Figure 8 on Page 40. Upon entering the Meter Reader Mode, the LCD will go blank for about 2-seconds. As with Serial Mode, the transmission of output volume pulses is suspended. Input volume pulses will continue to be counted. The instrument will then take pressure and temperature measurements and recalculate all item values prior to a LCD display.

Default Meter Reader Display

While in the Meter Reader Mode, the Mini-Max continues to recognize and accumulate meter input pulses. Also, 1 and 10-minute time-outs are used to automatically return the instrument to the Corrector Mode. By design, the Corrector Mode requires much less electrical energy than all other operating modes. The time-out periods are a safeguard to insure that the batteries are not needlessly wasted.

Refer to Figure 17 on Page 44. This is a flowchart of the default meter reader list. After the initial press of the push-button, the Mini-Max's operating program determines if there are any active alarms. Active alarms, while in the Corrector Mode, are indicated by displaying all decimal points in the corrected volume display LCD. If there are active alarms, all active alarm codes are displayed before the normal meter reader list items are displayed.

NOTE: While in the alarm display routine, all alarms may be cleared by allowing the instrument to time-out during the display of "E.E.E.E.E.E.E". If the instrument receives a push-button input during the "E.E.E.E.E.E.E" display, the alarms are not cleared and the sequence moves to the "Display Test" display. Refer to the section "Clearing Alarms" for more information.

The "Display Test" is the first meter reader list item. It provides a visual means of verifying that all LCD segments and decimal points are fully functional. If the "Display Test" does not appear as in Figure 16 on Page 43, the item code values and legends may not be accurately displayed.

When the Mini-Max receives a push-button input during the "Display Test", the current value for Uncorrected Volume is displayed. Each additional push-button input will cause the next item code value to scroll onto the LCD. As each item is displayed, the name of the item will be displayed first. If the push-button is pressed while the name is displayed, the LCD will scroll to the next item name without showing the item code value. This allows the operator to quickly scroll down to the desired item. When the last Meter Reader item is being displayed, a push-button input will cause the LCD to go blank for 1-second while the instrument processes any stored uncorrected input pulses, prior to returning to the Corrector Mode.

Listed below is the default Mini-Max Meter Reader List in the proper sequence:

Item Code	Item Description
061	DISPLAY TEST
002	UNCORRECTED VOLUME
000	CORRECTED VOLUME
—	GAS PRESSURE (LIVE)
—	GAS TEMPERATURE (LIVE)
048	BATTERY VOLTAGE

The Meter Reader List may be custom configured by using the Mini-Max Link Software to change Item Codes 130-135 and 75-86. Item Codes 130-135 are referred to as Mag List 1 and Item Codes 75-86 are referred to as Mag List 2.

The Default setup is listed below

Item Code	Item Name	Selected Item	Description
130	Mag List 1 Item #1	061	Display Test
131	Mag List 1 Item #2	002	Uncorrected Volume
132	Mag List 1 Item #3	000	Corrected Volume
133	Mag List 1 Item #4	255	End of List
134	Mag List 1 Item #5	255	End of List
135	Mag List 1 Item #6	255	End of List
075	Mag List 2 Item #1	048	Battery Voltage
076	Mag List 2 Item #2	255	End of List
077	Mag List 2 Item #3	255	End of List
078	Mag List 2 Item #4	255	End of List
079	Mag List 2 Item #5	255	End of List
080	Mag List 2 Item #6	255	End of List
081	Mag List 2 Item #7	255	End of List
082	Mag List 2 Item #8	255	End of List
083	Mag List 2 Item #9	255	End of List
084	Mag List 2 Item #10	255	End of List
085	Mag List 2 Item #11	255	End of List
086	Mag List 2 Item #12	255	End of List

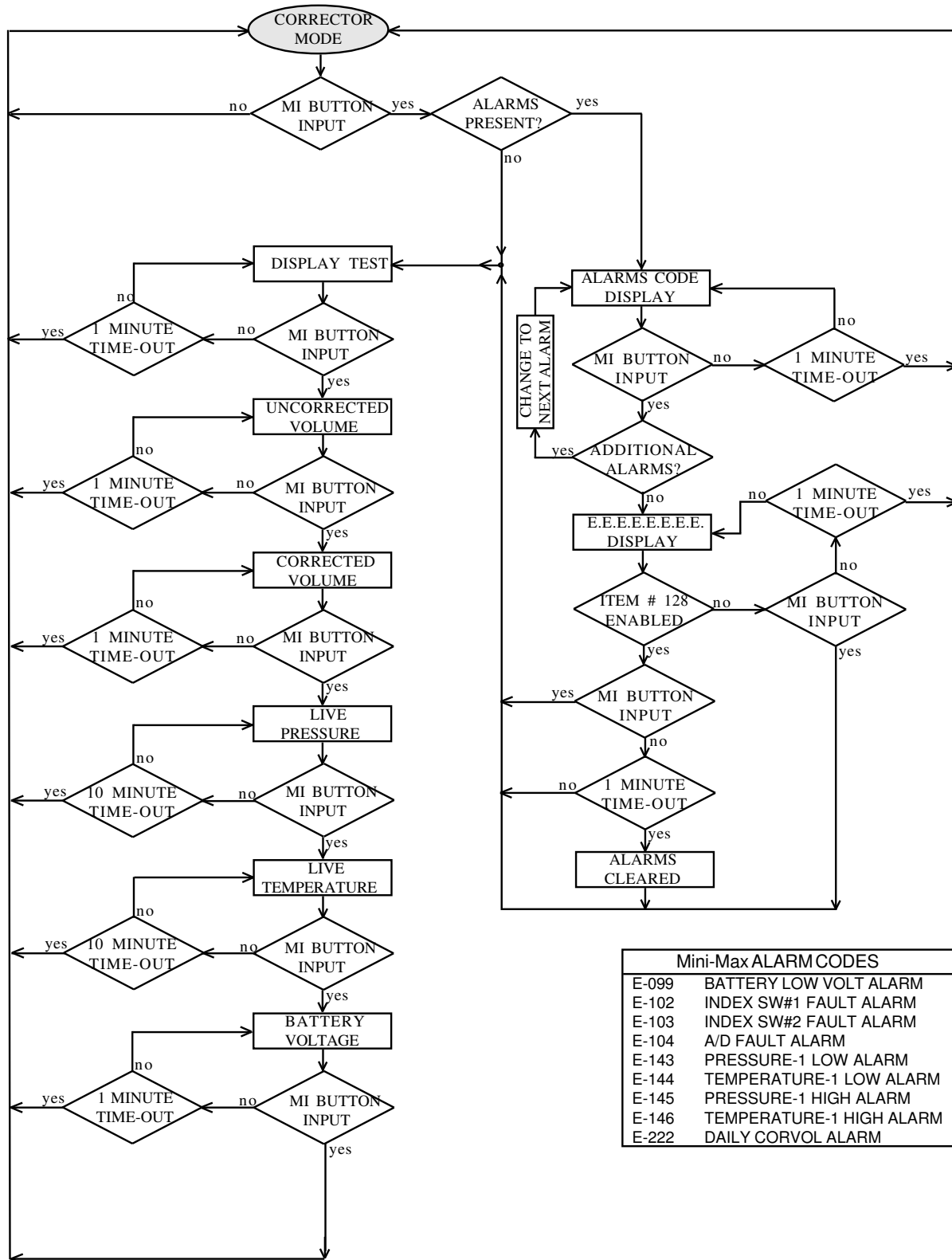

Mini-Max ALARM CODES	
E-099	BATTERY LOW VOLT ALARM
E-102	INDEX SW#1 FAULT ALARM
E-103	INDEX SW#2 FAULT ALARM
E-104	A/D FAULT ALARM
E-143	PRESSURE-1 LOW ALARM
E-144	TEMPERATURE-1 LOW ALARM
E-145	PRESSURE-1 HIGH ALARM
E-146	TEMPERATURE-1 HIGH ALARM
E-222	DAILY CORVOL ALARM

Fig. 17
Default Meter Reader Display

Live Parameters Display

The Live Parameter Display will allow Live Gas Pressure and Live Gas Temperature to be displayed. These should not be confused with Item Codes 008 (Gas Pressure) and 026 (Gas Temperature). The purpose of providing Live Gas Pressure and Live Gas Temperature is to allow the meter technician to monitor the gas pressure and temperature without attaching portable gauges.

Note: Remember, both live parameters have a 10-minute time-out.

Audit Trail

The Mini-Max records operational information on an hourly or daily basis. At the beginning of each Interval (Item Code 202), the instrument records four items into memory. The default settings are:

1. Item Code 258: 225 Incremental Corrected Volume
2. Item Code 259: 226 Incremental Uncorrected Volume
3. Item Code 260: 206 Interval Average Pressure
4. Item Code 261: 207 Interval Average Temperature

The Mini-Max will store up to 40 days of daily information for these four items. The Mini-Max AT (with extended Audit Trail) will store up to 40 days of hourly information. After all available records are used, the earliest information will begin to be overwritten by new information. The Audit Trail can be downloaded using Mini-Max Link software (or MasterLink32).

The Audit trail items can be changed using Mini-Max Link software (or MasterLink32) and changing Item Codes 258-261. Any Mini-Max item can be selected for the Audit Trail, and the number placed in Item Codes 258-261.

Instrument Calibration

There is one method to calibrate the gas pressure and gas temperature transducers in the Mini-Max. The method requires the use of a computer and Mini-Max Link software. This method requires known values of the applied pressure and/or temperature as a reference.

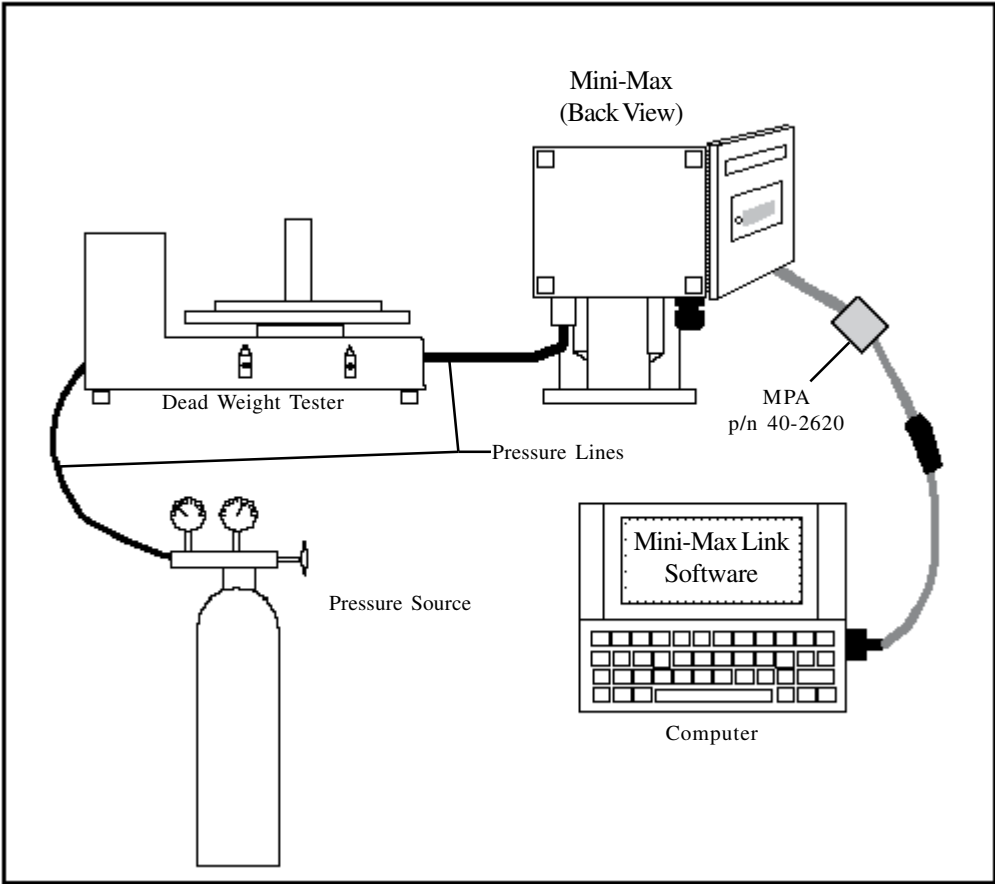

Fig. 18
2-Point Pressure Calibration

2-Point Pressure Calibration (Defined)

A 2-Point Pressure Calibration requires two different pressures be applied to the instrument's pressure transducer and be sampled by the data acquisition circuits. A low pressure value, usually 0.00 PSI, is applied to determine the Pressure Zero Calibration (offset). A higher pressure value is applied to determine the Pressure Span Calibration (gain). The default Calibration Parameters require that the Span Pressure exceed the Zero Pressure by at least 50% of the transducer range, otherwise a "Points Too Close" error message is displayed.

To produce a linear pressure response for all rated pressures and temperatures, each transducer has been factory characterized for ambient temperature effects. The characterization process determines the proper compensation coefficients for each transducer. The 2-point calibration process uses the coefficients when calculating the pressure offset and pressure span values. Once these two points have been calculated and stored in the instrument's memory, all other applied pressures are automatically linearized and temperature compensated by the coefficients.

2-Point Pressure Calibration (Gauge Transducers)

2-POINT PRESSURE CALIBRATION (ITEMS REQUIRED)

- Mini-Max Corrector
- Pressure source and fittings (capable of providing pressures of at least 50% of the Mini-Max's pressure transducer range)
- Pressure Reference (accuracy to equal or exceed the accuracy of the Mini-Max's pressure system)
- Computer (IBM Compatible)
- Mini-Max Link Software
- I/O cable, p/n 40-1629
- MPA, p/n 40-2620

2-POINT PRESSURE CALIBRATION (PROCEDURE)

Make certain that the Pressure Compensation Coefficients listed in Item Codes 301 through 332 are for the pressure transducer installed. Also verify that Item Code 087 is the desired pressure unit. Item Code 138 matches the transducer serial number label and Item Code 112 is set for **Gauge** type transducer. Refer to Figure 18 on Page 46 when pressure calibrating the Mini-Max. Since the two-point calibration is mostly a software function, references to the appropriate sections in the Mini-Max Link software are included.

- 1) Connect the pressure source and pressure reference to the Mini-Max's pressure connector.
- 2) Using serial cable p/n 40-1629, and MPA p/n 40-2620, connect from the computer's serial port to the Mini-Max's serial port.
- 3) Start Mini-Max Link software on the computer.
- 4) Enter the access code for Level 1 or Level 2 when requested. The default Level 1 Access Code is "11111", the default Level 2 Access Code is "22222".
- 5) If a communications link has not yet been established, the screen will display a box requesting the user to input the Instrument Access Code. Enter the access code when this box appears. The default code is "33333".

- 6) Select “Calibrate” from the main menu.
- 7) Select “Pressure Calibration” from the sub-menu.
- 8) With zero pressure applied to the Mini-Max’s pressure transducer, perform the “Pressure Zero Calibration.” The pressure displayed in green on the computer’s screen is a live reading. This permits the user to determine if the pressure has stabilized so that a sample may be obtained. Click the AVERAGE PRESSURE NOW button when it becomes active (text changes from gray to black) to obtain a sample of the applied pressure.
- 9) When Mini-Max Link displays “Average Pressure”, the value should be changed to match the pressure reference by clicking the CHANGE button when it becomes active. Enter the pressure value for the zero reference pressure (usually 0.00). The Mini-Max will calculate the required difference (offset), store this calculated value at Item Code 017, display the new value for Item Code 017, and the previous value at Item Code 018, before returning to a live pressure reading.
- 10) Compare the displayed pressure to the reference pressure. If the Mini-Max’s pressure reading is not acceptable, click the AVERAGE PRESSURE NOW button again to obtain another pressure sample. The program will continue to loop back to the live pressure reading. Obtain as many pressure samples as necessary until an acceptable pressure reading is displayed.
- 11) If the Mini-Max’s zero pressure reading is acceptable, click the SPAN button to change to the Span Calibration sequence.
- 12) The screen title should have changed to “Pressure Span Calibration.” At this point, the software is waiting to sample the applied pressure. Increase the pressure applied to the Mini-Max to the span reference pressure. This must be greater than 50% of the transducer range.

Example #1: If the zero reference pressure on a 100 PSI transducer equals 0.00 PSI, then the span reference pressure must be between 50.00 and 100.00 PSI.

Example #2: If the zero reference pressure on a 600 PSI transducer equals 0.00 PSI, then the span reference pressure must be between 300.00 and 600.00 PSI.

- 13) The span calibration also displays a live pressure reading to allow the user to determine if the span reference pressure has stabilized. When the pressure has stabilized, click the AVERAGE PRESSURE NOW button when it becomes active to obtain a pressure sample.
- 14) If the average pressure reading is not equal to the span reference pressure, click the CHANGE button when it becomes active. Enter the pressure value for the span reference pressure. As the computer screen updates, the MINI-MAX will calculate the required span (gain), store this calculated value at Item Code 020, display the new values for Items 017 and 020, and display the previous values at Item Codes 018 and 021 before returning to a live pressure reading. Obtain as many pressure samples as necessary until an acceptable span pressure reading is displayed.
- 15) Compare the average pressure reading to the span reference pressure. If the average pressure reading is acceptable, the pressure calibration process is complete. As a suggestion, recheck the pressure zero reading and any number of pressure points within the transducer range, or click DONE to exit the calibration sequence.

2-Point Pressure Calibration (Absolute Transducers)

2-POINT PRESSURE CALIBRATION (ITEMS REQUIRED)

- Mini-Max
- Pressure Source and fittings (capable of providing pressures of at least 50% of the Mini-Max's pressure transducer range)
- Pressure Reference (accuracy to equal or exceed the accuracy of the Mini-Max's pressure system)
- Computer (IBM Compatible)
- Mini-Max Link Software
- I/O cable, p/n 40-1629
- Barometer
- MPA, p/n 40-2620

2-POINT PRESSURE CALIBRATION (PROCEDURE - ABSOLUTE)

Make certain that the Pressure Compensation Coefficients listed in Item Codes 301 through 332 are for the pressure transducer installed. Also verify that Item Code 087 is the desired pressure unit. Item Code 138 matches the transducer serial number label and Item Code 112 is set for **Absolute** type transducer. Refer to Figure 18 on Page 46 when pressure calibrating the Mini-Max. Since the two-point calibration is mostly a software function, references to the appropriate sections in the Mini-Max Link software are included.

- 1) Connect the pressure source and pressure reference to the Mini-Max's pressure connector.
- 2) Using serial cable p/n 40-1629, and MPA p/n 40-2620, connect from the computer's serial port to the Mini-Max's serial port.
- 3) Start Mini-Max Link software on the computer.
- 4) Enter the access code for Level 1 or Level 2 when requested. The default Level 1 Access Code is "1111", the default Level 2 Access Code is "2222".
- 5) If a communications link has not yet been established, the screen will display a box requesting the user to input the Instrument Access Code. Enter the access code when this box appears. The default code is "3333".
- 6) Select "Calibrate" from the main menu.
- 7) Select "Pressure Calibration" from the sub-menu.
- 8) With zero pressure applied to the Mini-Max's pressure transducer, perform the "Pressure Zero Calibration." The pressure displayed in green on the computer's screen is a live reading. This permits the user to determine if the pressure has stabilized so that a sample may be obtained. Click the AVERAGE PRESSURE NOW button when it becomes active (text changes from gray to black) to obtain a sample of the applied pressure.
- 9) Obtain the current local atmospheric pressure reading using a barometer or by some other means. When Mini-Max Link displays "Average Pressure", the value should be changed to match the current atmospheric pressure value by clicking the CHANGE button when it becomes active. Enter the current atmospheric pressure value, making sure the units are comparable, i.e., PSIA. The Mini-Max will calculate the required difference (offset). Store this calculated value at Item Code 017, display the new value for Item Code 017 and the previous value at Item Code 018, before returning to a live, absolute pressure reading.

- 10) Compare the displayed pressure to the reference pressure. If the Mini-Max's absolute pressure reading is not acceptable, click the AVERAGE PRESSURE NOW button again to obtain another pressure sample. The program will continue to loop back to the live pressure reading. Obtain as many pressure samples as necessary until an acceptable pressure reading is displayed.
- 11) If the Mini-Max's absolute pressure reading is acceptable, click the SPAN button to change to the Span Calibration sequence.
- 12) The screen title should have changed to "Pressure Span Calibration." At this point, the software is waiting to sample the applied pressure. Increase the pressure applied to the Mini-Max to the span reference pressure that exceeds the zero reference pressure by at least 50% of the rated transducer range.

Example #1: If the zero reference pressure on a 100 PSIA transducer equals 14.73 PSIA, then the span reference pressure must be between 64.73 and 100.00 PSI.

Example #2: If the zero reference pressure on a 100 PSIA transducer equals 13.25 PSIA, then the span reference pressure must be between 63.25 and 100.00 PSI.

Example #3: If the zero reference pressure on a 600 PSIA transducer equals 14.73 PSIA, then the span reference pressure must be between 314.73 and 600.00 PSI.

- 13) The span calibration also displays a live pressure reading to allow the user to determine if the span reference pressure has stabilized. When the absolute pressure has stabilized, click the AVERAGE PRESSURE NOW button when it becomes active to obtain a pressure sample.

NOTE: The span reference pressure is equal to the sum of the dead weight tester pressure, plus the atmospheric pressure obtained in step 9 above.

- 14) If the average pressure reading is not equal to the span reference pressure, click the CHANGE button when it becomes active. Enter the pressure value for the span reference pressure. As the computer screen updates, the Mini-Max will calculate the required span (gain), store this calculated value at Item Code 020, display the new values for Item Codes 017 and 020, and display the previous values at Item Codes 018 and 021 before returning to a live pressure reading. Obtain as many pressure samples as necessary until an acceptable span pressure reading is displayed.
- 15) Compare the average, absolute pressure reading to the span reference pressure. If the average pressure reading is equal to the sum of the applied pressure plus the atmospheric pressure, the pressure calibration process is complete. As a suggestion, recheck the pressure zero reading and any number of pressure points within the transducer range, or click DONE to exit the calibration sequence.

2-Point Temperature Calibration (Defined)

A 2-Point Temperature Calibration requires that two different temperatures be applied to the instrument's temperature probe and be sampled by the data acquisition circuits. A low temperature source, usually an ice bath (32 degrees F.) is used to determine the Temperature Zero Calibration. A higher temperature source is used to determine the Temperature Span Calibration (gain). The default Calibration Parameters requires the Span Temperature to exceed the Zero Temperature by at least 10% of the instrument's temperature range.

The temperature probe provides a nonlinear, but very predictable temperature response for all rated temperatures. The firmware of the instrument contains the required information to produce a linear temperature response for any connected temperature probe. The 2-point calibration process uses the temperature offset and temperature span values to adjust for individual sensor variations. Once these two points have been calculated and stored into memory, all other applied temperatures can be determined by a linear interpolation.

2-point temperature calibration (items required)

- Mini-Max
- A cold temperature source (ice bath)
- A hot temperature source (heated water, not to exceed 150 degrees F.)
- Temperature reference (calibrated thermometer)
- Computer (IBM compatible)
- Mini-Max Link Software
- I/O cable, p/n 40-1629
- MPA, p/n 40-2620

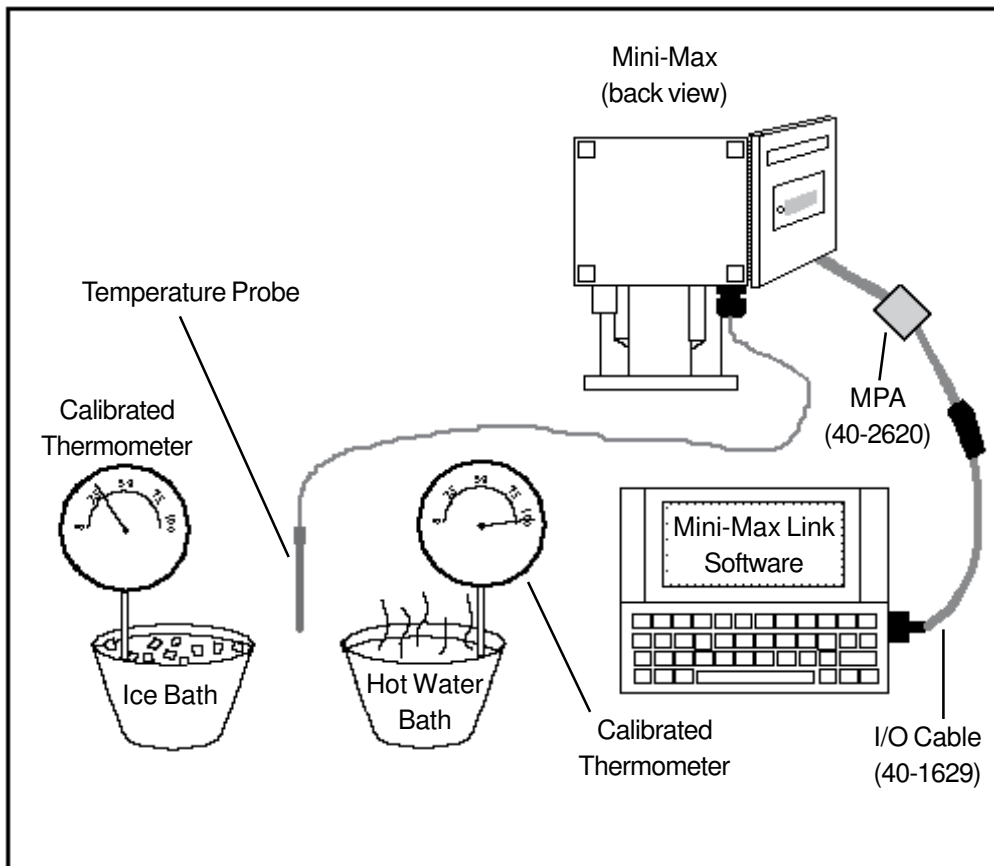

Fig. 19
2-Point Temperature Calibration

2-point temperature calibration (procedure):

Refer to Figure 19 on Page 51 when temperature calibrating the Mini-Max. Since the 2-point calibration is mostly a software function, references to the appropriate sections in the Mini-Max Link software are included.

- 1) Prepare an agitated ice bath and a container of heated water.
- 2) Using serial cable p/n 40-1629, connect from the computer's serial port to the MPA then to the Mini-Max's serial port.
- 3) Start Mini-Max Link software on the computer.
- 4) Enter the access code for Level 1 or Level 2 when requested. The default Level 1 Access Code is "11111", the default Level 2 Access Code is "22222".
- 5) If a communication link has not yet been established, the screen will display a box requesting the user to input the Instrument Access Code. Enter the access code when this box appears. The default code is "33333".
- 6) Select "Calibrate" from the main menu.
- 7) Select "Temperature Calibration" from the sub-menu.
- 8) With the tip of the temperature probe lowered into an agitated ice bath, perform the "Temperature Zero Calibration." The temperature displayed in green on the computer's screen is a live reading. This permits the user to determine if the temperature has stabilized so that a sample may be obtained. Click the AVERAGE TEMPERATURE NOW button when it becomes active (text changes from gray to black) to obtain a sample of the temperature.
- 9) When Mini-Max Link displays "Average Temperature", the value should be changed to match the reading of the calibrated thermometer by clicking the CHANGE button when it becomes active. Enter the temperature value for the zero reference temperature (usually 32 degrees F.). The Mini-Max will calculate the required difference (offset), store this calculated value at Item Code 035, and display the new value for Item Code 035 and the previous value at Item Code 036 before returning to a live temperature reading.
- 10) Compare the displayed temperature to the reference temperature. If the Mini-Max's temperature reading is not acceptable, click the AVERAGE TEMPERATURE NOW button again to obtain another temperature sample. The program will continue to loop back to the live temperature reading. Obtain as many temperature samples as necessary until an acceptable temperature reading is displayed.
- 11) If the Mini-Max's zero temperature reading is acceptable, click the SPAN button to change to the Span Calibration sequence.
- 12) The screen title should have changed to "Temperature Span Calibration." At this point, the software is waiting to sample a temperature that exceeds the zero reference temperature by at least 10% of the instrument's temperature range, i.e., a temperature greater than 51.0 degrees F. Insert the temperature probe into the container of heated water.
- 13) The span calibration also displays a live temperature reading to allow the user to determine if the span reference temperature has stabilized. When the temperature has stabilized, click the AVERAGE TEMPERATURE NOW button when it becomes active to obtain a temperature sample.
- 14) If the average temperature reading is not equal to the span reference temperature, click the CHANGE button when it becomes active. Enter the temperature value from the thermometer in the heated-water bath. As the computer screen updates, the Mini-Max will calculate the required span (gain), store this calculated value at Item Code 035, display the new values for Item Codes 035 and 038, and display the previous values at Item Codes 036 and 039 before returning to a live temperature reading. Obtain as many temperature samples as necessary until an acceptable span temperature reading is displayed.
- 15) Compare the average temperature reading to the span reference temperature.
If the average temperature reading is acceptable, the temperature calibration process is complete. As a suggestion, recheck the temperature zero reading and any number of temperature points within the transducer range, or click the DONE button to exit the calibration sequence.

Taking the Mini-Max “Unconfigured”

“Unconfigured” refers to setting the configuration to factory default settings. After the Mini-Max goes unconfigured, Audit Trail, totalized volumes, calibration information, and instrument settings are all cleared. Therefore, it is important to record this information before taking the Mini-Max unconfigured. Specific information about downloading this information is available in the [Mini-Max Link Software Manual](#).

There are two methods to take the Mini-Max unconfigured the first is through the Mini-Max Link Software, and the second is a hardware method that is useful if a serial link cannot be established.

Software method:

- 1) Put the instrument into “Shutdown” using Mini-Max Link or MasterLink32 software.
- 2) Send the “unconfigure” command using Mini-Max Link or MasterLink32 software.
- 3) The Mini-Max’s LCD should display “00000000” indicating that the instrument is operating in the Corrector Mode.
- 4) Reconfigure the instrument to your company’s specifications. **NOTE: The baud rate will be unconfigured so the unit will have to go through auto baud rate detection again.**

Hardware method (use only if serial link cannot be established):

- 1) Remove JP1 (this disconnects the supercap)
- 2) Disconnect the Battery (the board is now powered down)
- 3) While holding in the MI button, connect the battery, and continue to hold the MI button for at least 10 seconds. You should see P P P P P P P P on the display, indicating that the instrument has been reset to defaults.
- 4) Release the MI button.
- 5) Replace JP1 (very important)

Putting the Mini-Max into “Shutdown”

Shutdown is a mode of operation invoked by the user prior to placing the instrument into storage or prior to performing some type of board maintenance. The Mini-Max Link software manual describes the procedure for putting the Mini-Max into shutdown. There are two types of Shutdown that can be induced into the Mini-Max: Partial and Complete. The connection status of the battery packs determines which type of Shutdown the instrument assumes.

1) **Partial Shutdown:** To put the Mini-Max into “partial shutdown”, from Mini-Max Link software, select and confirm “SHUTDOWN” from the “Instrument” menu. Leave the main battery plugged-in.

In partial shutdown, the instrument’s real-time clock will continue to update; however, new volume pulses will not be counted and the instrument will not display corrected gas volume. The LCD will show dashes “- - - - -” across the display. The instrument still draws normal background current from the main battery when placed in partial shutdown, and it preserves all item values and audit trail information.

To recover from a partial shutdown, i.e., return to Corrector Mode, simply press the MI button.

2) **Complete Shutdown:** To put the Mini-Max into “complete shutdown”, from Mini-Max Link software, select and confirm “SHUTDOWN” from the “Instrument” menu, then unplug the main battery, and remove the super cap jumper. In complete shutdown, the clock of the instrument will stop working and new uncorrected volume pulses will not be counted. The configuration data of the instrument and all item values are retained in E²PROM. The LCD display will go blank once the batteries are unplugged.

In order to bring the Mini-Max out of a complete shutdown, simply plug in the main battery and replace the super cap jumper. It will be necessary to reset the date, time, corrected volume, uncorrected volume and other items that are not current as a result of the complete shutdown.

Firmware Reprogramming

Mini-Max firmware (instrument operating program) is stored in flash memory. Adding new features and capabilities to the instrument is simply a matter of uploading a file containing a newer version of firmware through the serial port connection. There are no EPROM chips to be removed or plugged into sockets. Flash Access Security is provided by the use of the Mercury Programming Adapter (MPA). To upgrade flash memory, use the software application **Firmware Upgrade Manager**.

Items Required

□ PC with Windows 95/98 OS (or higher)

□ **Firmware Upgrade Manager** software (FWUM) version 2.1101 or later

Install Firmware Upgrade Manager on your computer using the following steps:

- Insert the 3 1/2" floppy containing Firmware Upgrade Manager (disk #1) into your computer floppy drive.
- Click the windows **Start** button and select **Run** from the Start Menu
- In the run box, type in **A:\setup.exe**
- The screen will display: "Firmware Upgrade Manager Setup". At the bottom of the screen will be a dialogue box to choose the installation drive (default is C:\). Select the drive letter you wish to install to and press continue.
- Setup will begin to install the files for Firmware Upgrade Manager from disk #1. After disk #1 is complete, setup will prompt for disk #2. Insert disk #2 and continue the installation.
- At the end of the installation, there will be a message stating that the installation is complete. At this point, setup will give you the option of restarting the computer to update the system. Select "Yes" to update the system and restart the computer.

□ **MasterLink32** software version 3.30 or later

□ **Mercury Programming Adaptor** (MPA) p/n 20-2620, with version 1.1002 firmware or higher

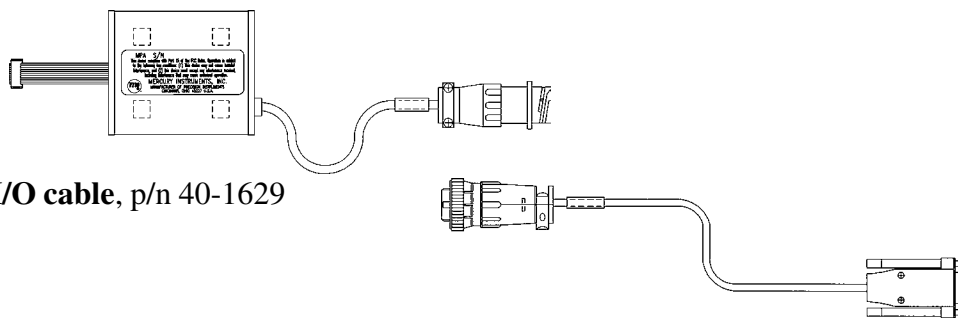

□ **RS-232 serial I/O cable**, p/n 40-1629

□ **Mini-Max Firmware file** (maxXXXXX.mmf or maxXXXXX.mmx)

□ **Mini-Max Mainboard** (p/n 40-2572)

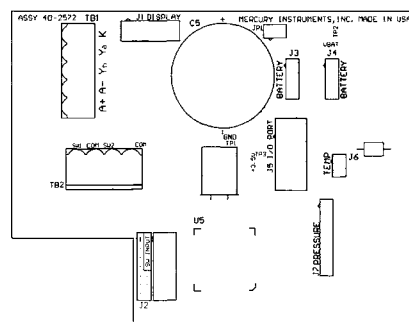

Before Upgrading Firmware (saving instrument data):

1. Open MasterLink32 software
2. Connect the MPA ribbon cable connector to J5 on the printed circuit board. **If the Serial I/O Board is installed in J5, remove it before connecting the MPA**
3. Connect the Serial Cable (40-1629) from the MPA to the computer COM port.

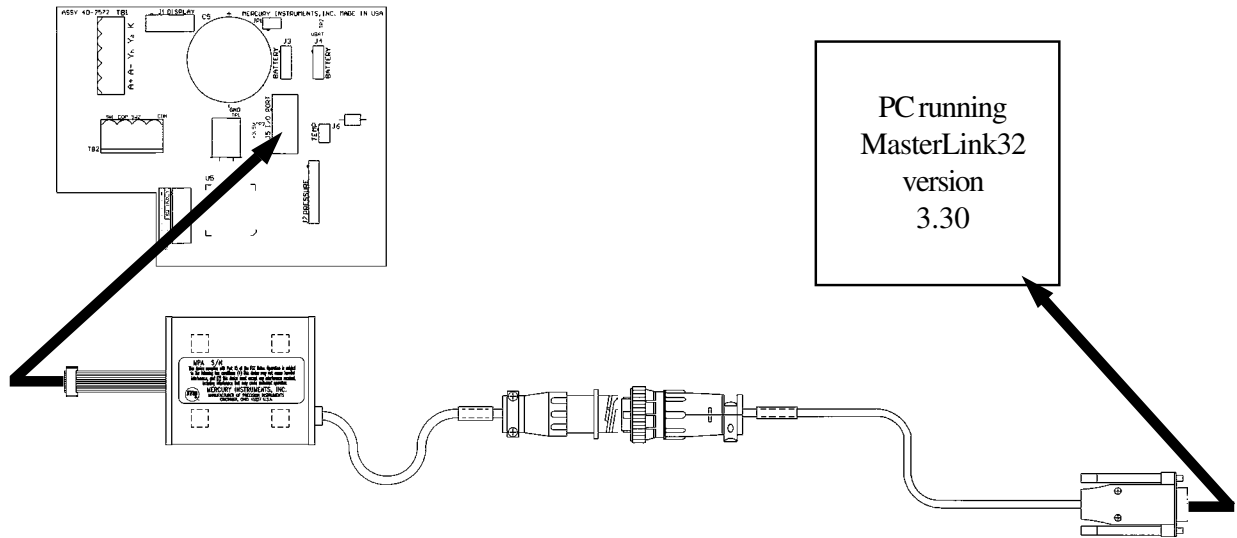

4. From the Transfer Menu, select Read Item File.

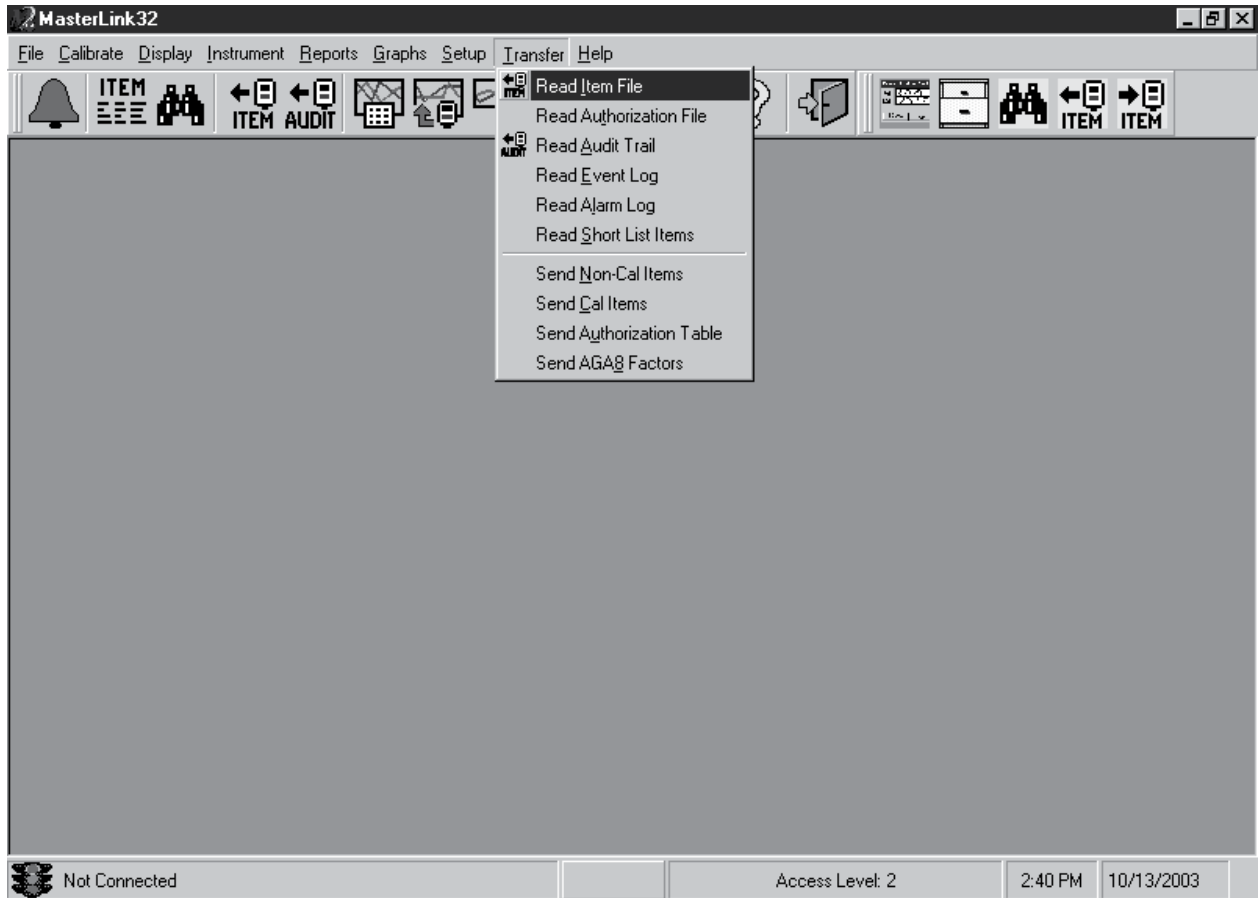

5. MasterLink will establish a link with the Mini-Max and display a dialogue box. Type in a name for the item file and click the Save button. MasterLink will then save all items to a file with the selected filename.

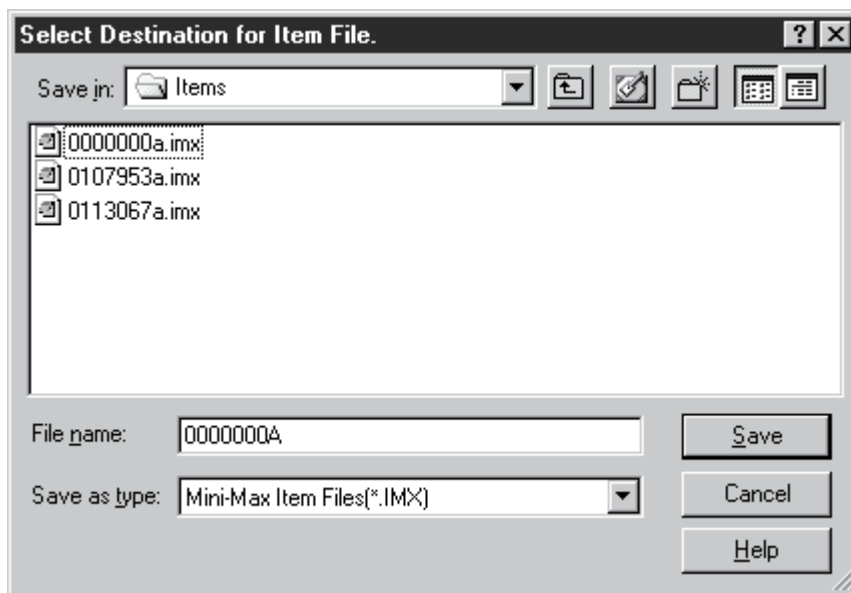

6. After the item file is downloaded, click OK and then select Read Audit Trail from the Transfer Menu

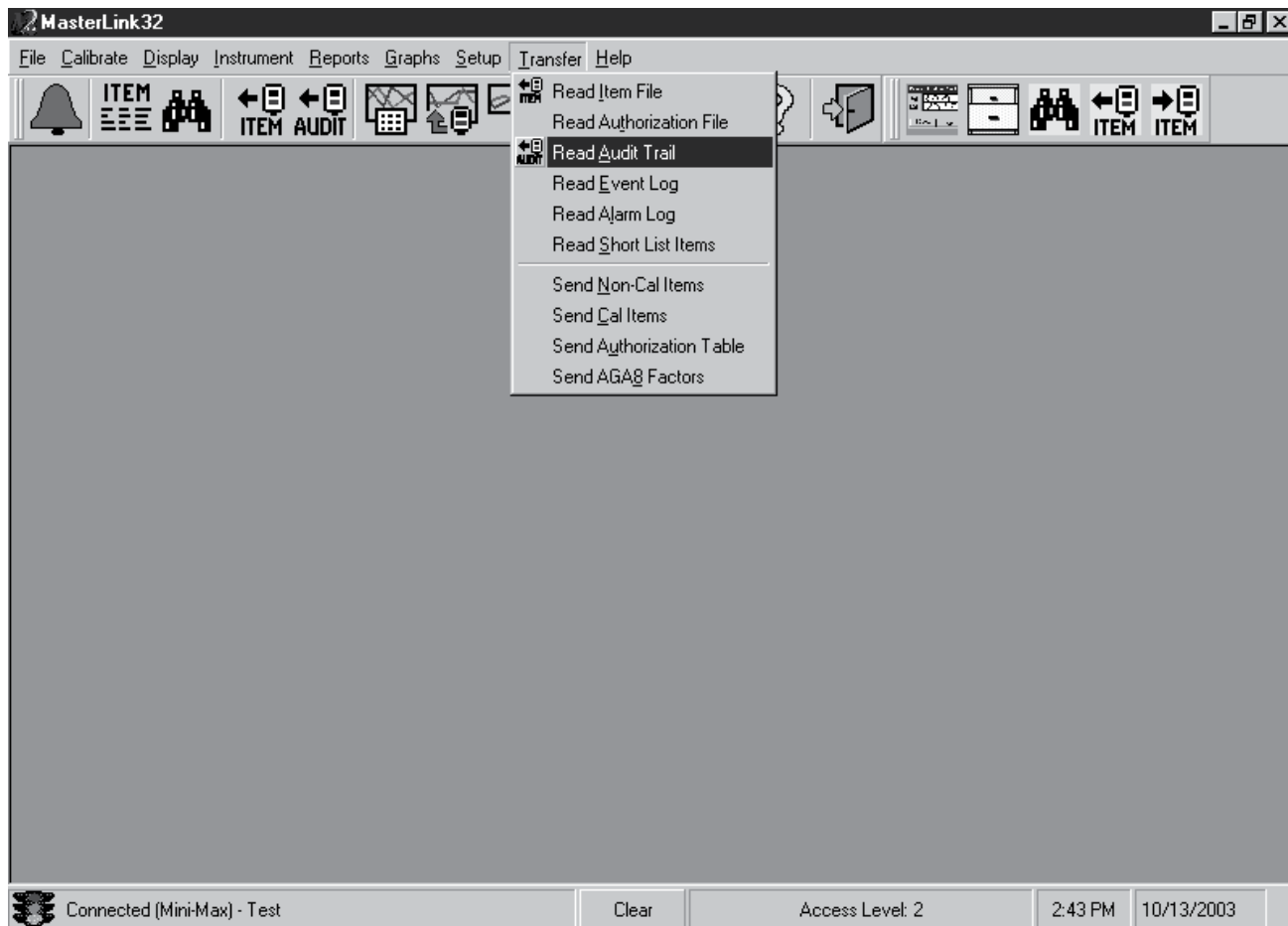

8. Select the Last N Days radio button from the option screen and type 40 into the blank. Click OK and MasterLink will read the last 40 days of Audit Trail information from the Mini-Max.

Read Audit Trail Data

Site Name: Test
Site Id: 00000000 - 00000000

Date Range

Since Last Download: 4/3/2002 4:08:22 PM

Last N Days: 40

Since:(mm/dd/yyyy) 4/3/2002 16:08:22

From/To: (mm/dd/yyyy) 9/9/2002 15:00:00
11/21/2002 23:00:00

Other Options

Download Item List

Purge 4 Item Duplicate Data

Conversion File Options

Include Conversion File

New Events Only

Old Events Only

All Events

OK Cancel

9. After the download is complete, disconnect the link and exit MasterLink32 software. Remove the MPA ribbon cable connector from J5 of the Mini-Max mainboard.

Procedure to upgrade Mini-Max firmware:

1. Connect the MPA ribbon cable connector to J5 on the printed circuit board. **If the Serial I/O Board is installed in J5, remove it before connecting the MPA**
2. Connect the Serial Cable (40-1629) from the MPA to the computer COM port.

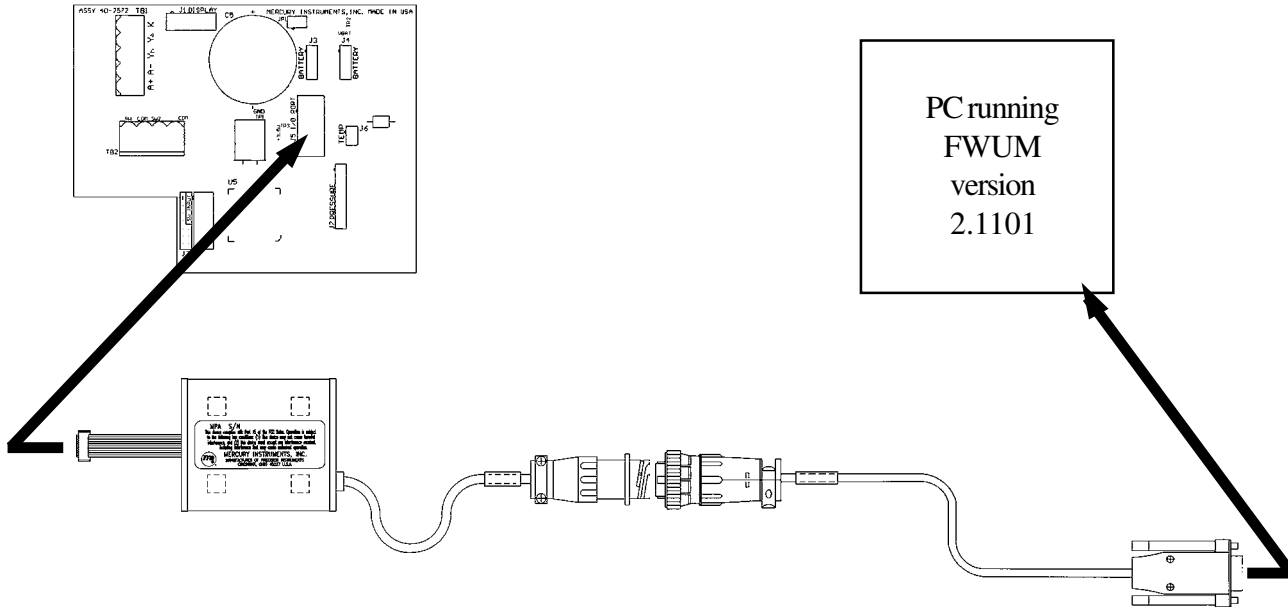

3. Open **Firmware Upgrade Manager** by double clicking on the icon.
4. Select “Send Mini-Max Firmware” by clicking the **Mini-Max button**.

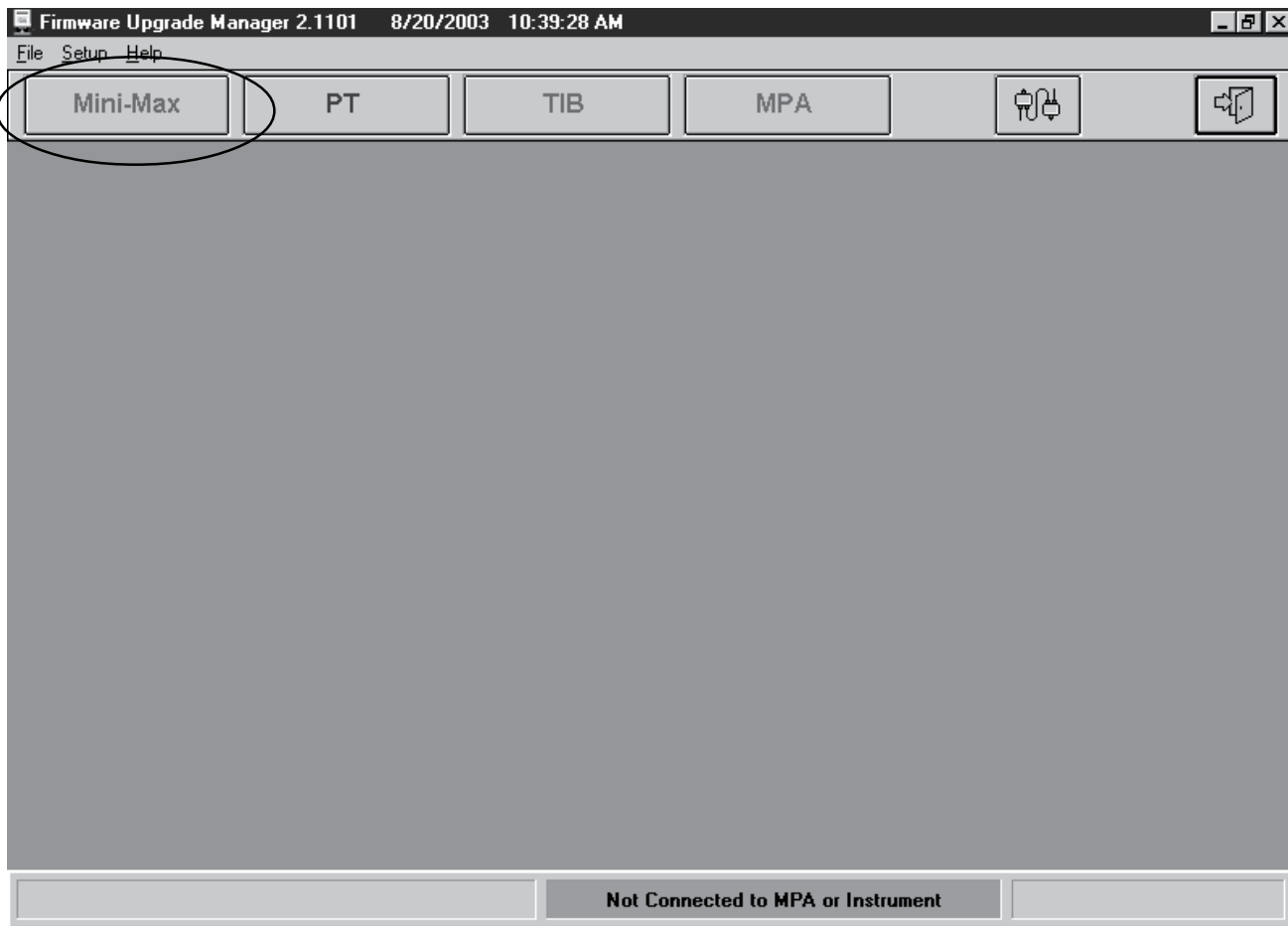

5. After clicking the Mini-Max button, a dialogue box will appear. Select the Mini-Max firmare file (maXXXXX.mmx) and click OK.

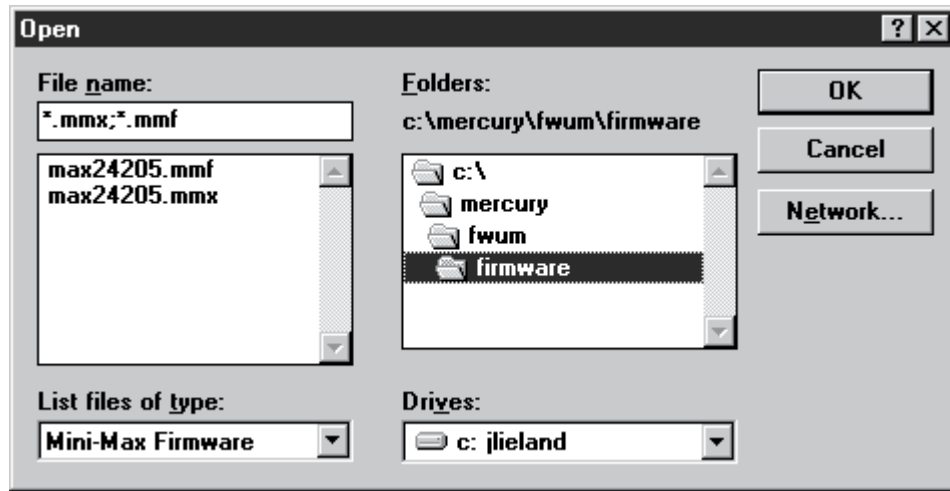

6. At this point the software will attempt to link to the MPA and establish a connection with the instrument. When this is completed, another dialogue box will appear. Make sure that the correct file is in the Firmare File box and that none of the check boxes are checked. Click Begin to upload the new firmware into the instrument.



7. **Firmware Upgrade Manager** will now automatically upgrade the firmware and then verify the upload.

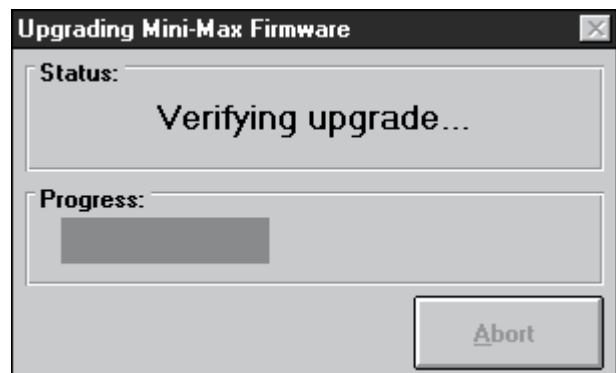
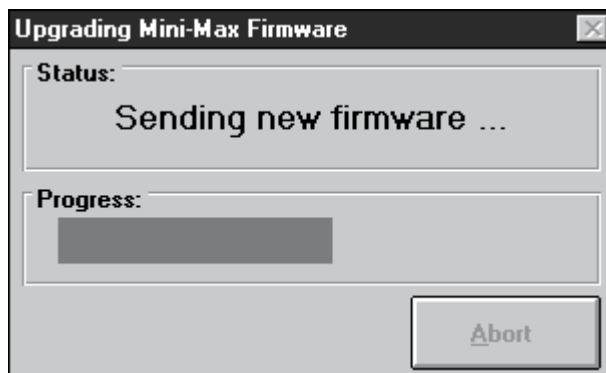

8. Firmware upgrade is now completed. You can now disconnect all cables. [If the serial I/O board was disconnected in step #1, reconnect it at this time.](#)

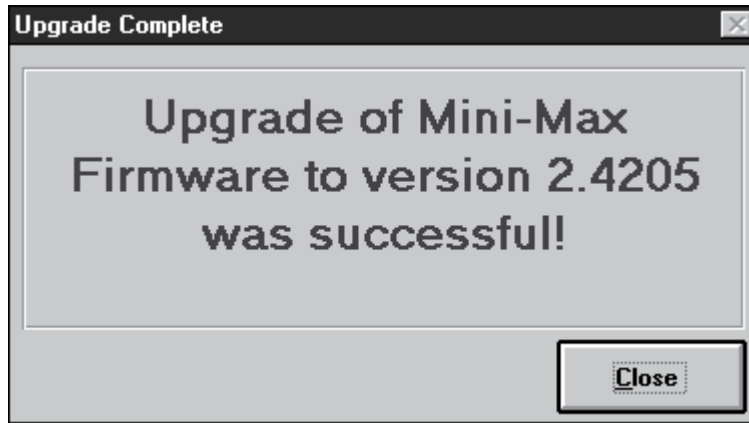

After Upgrading Firmware (restoring instrument configuration):

1. Open MasterLink32 software
2. Connect the MPA ribbon cable connector to J5 on the printed circuit board. **If the Serial I/O Board is installed in J5, remove it before connecting the MPA**
3. Connect the Serial Cable (40-1629) from the MPA to the computer COM port.

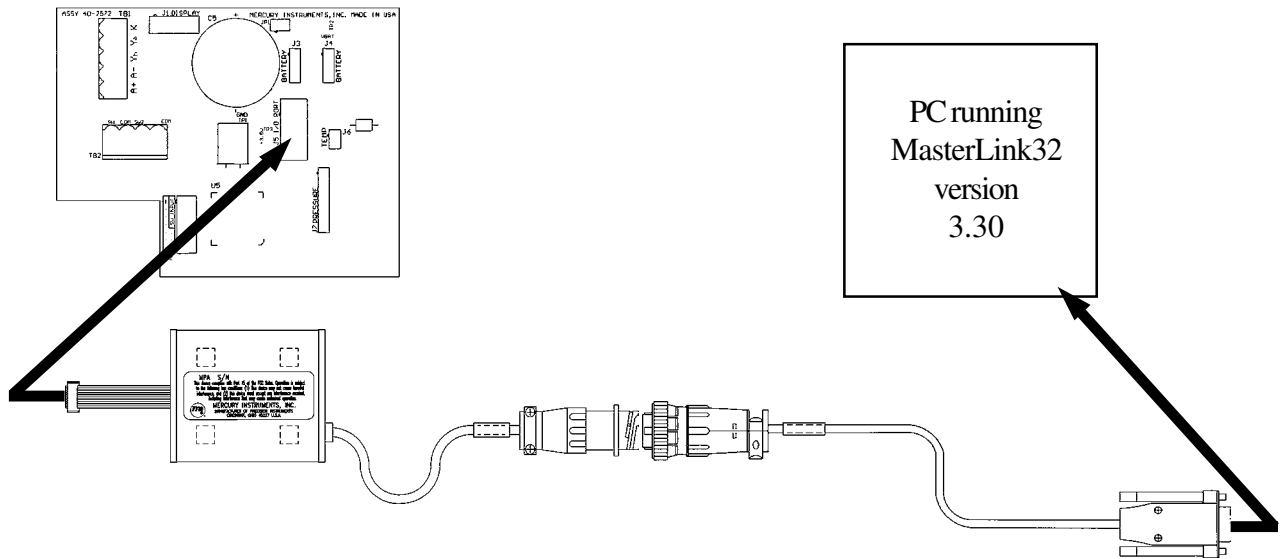

4. From the Transfer Menu, select Send Non-Cal Items

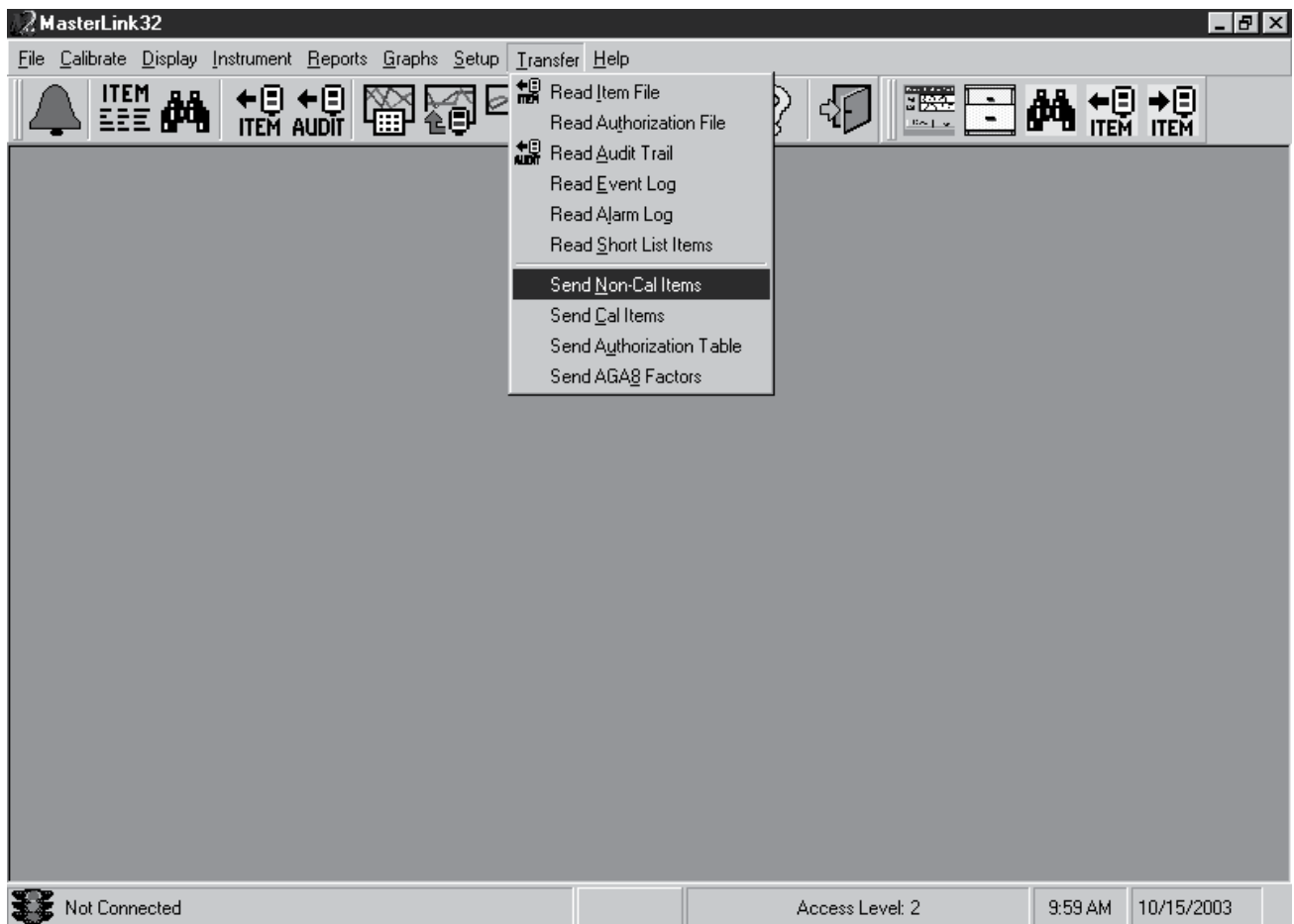

5. Select the Item File that was saved in step 4 of the Pre-Firmware upgrade procedure from the list and click the Open button.

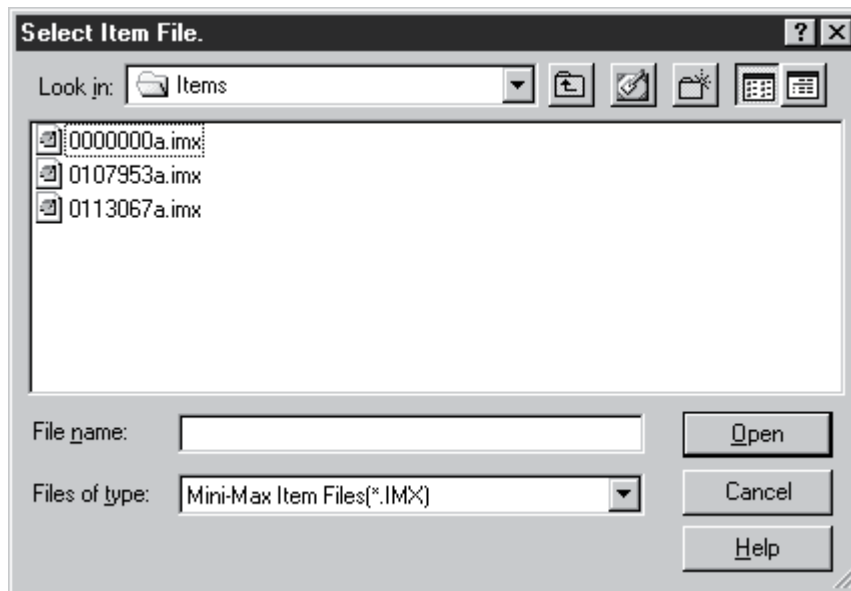

6. From the Transfer Menu, select Send Cal Items

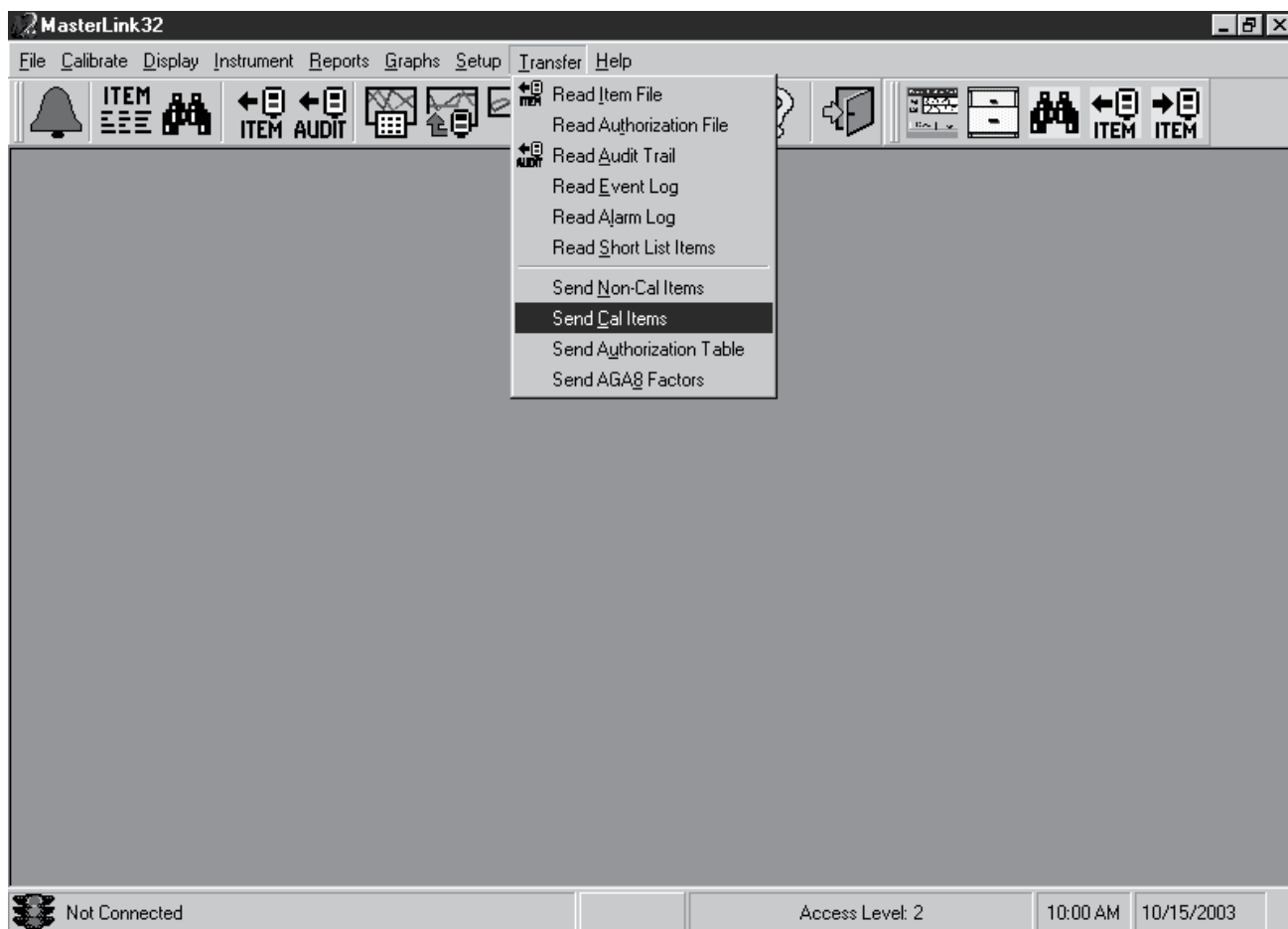

7. MasterLink will display a warning message stating that “Transducer coefficients should not be altered.” Click the Yes button to continue. MasterLink will now display a Calibration Options window. Make sure all boxes are checked and click OK to continue.

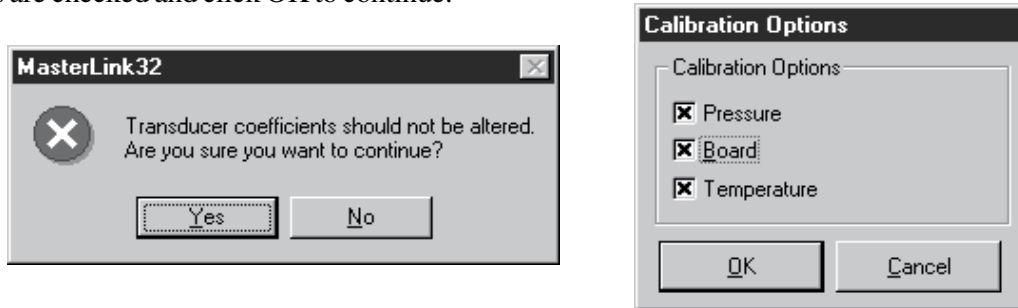

8. From the Instrument Menu, select Set Instr. Date/Time via computer.

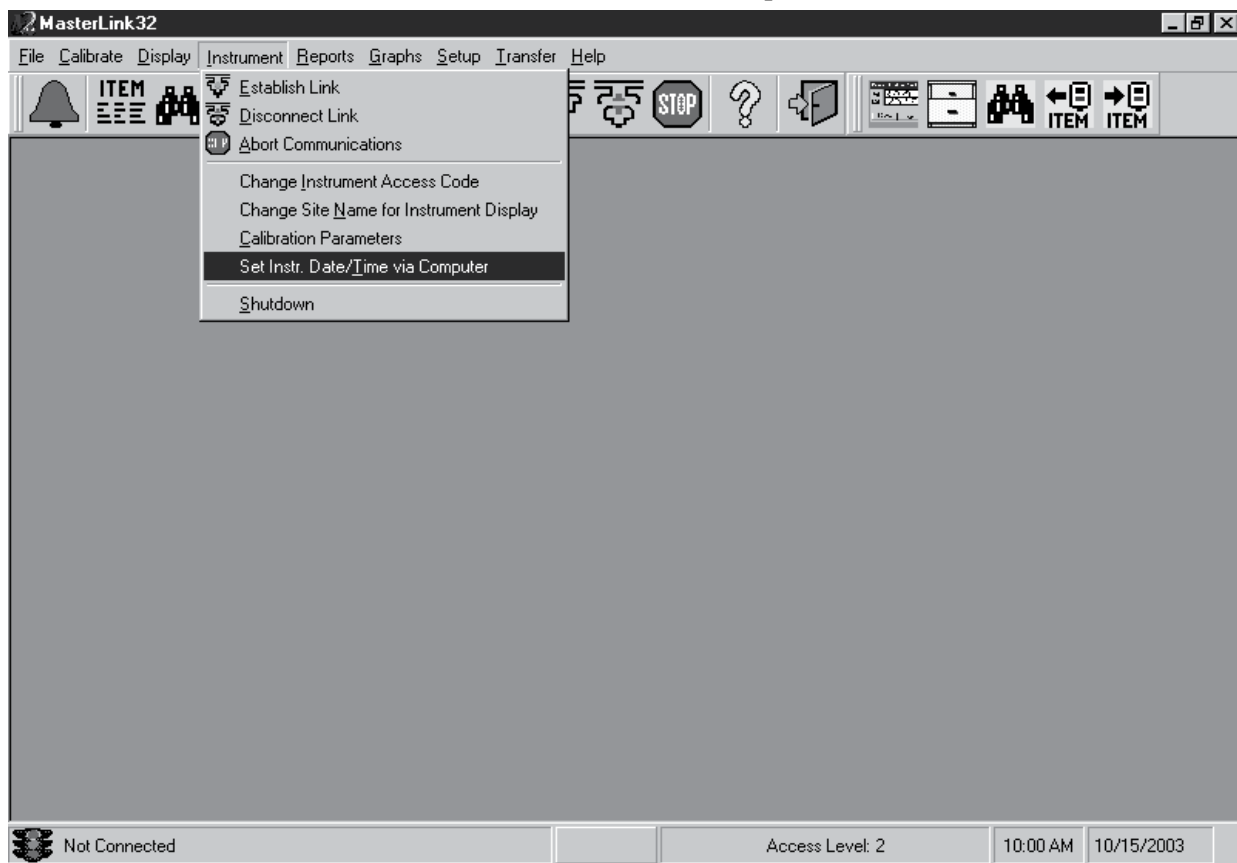

9. Verify that the correct time and date are being sent to the instrument. Click Yes to send the time and date and finish the instrument setup.

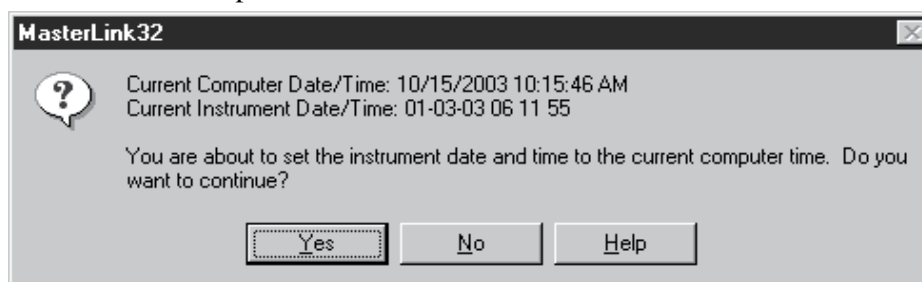

Item Code List

Items which make up the operating parameters, codes, alarms, calibration references, voltage levels, and other information relative to operation or configuration of the Mini-Max are listed below. Item code information can only be changed using Mini-Max software. Refer to the Mini-Max Software Manual for more information.

Item No.	Item Name	Description
000	Corrected Volume	Totalized Corrected Volume, corrected to base conditions (PT&S). Value is scaled to volume units selected at Item 090, with the number of digits defined by Item 096.
002	Uncorrected Volume	Totalized Uncorrected Volume. Value is scaled to volume units selected at Item 092, with the number of digits defined by Item 097. UncVol should agree with the mechanical index if initially synchronized.
005	Pulser A # of Pulses	Value represents twice the number of Pulser A output pulses remaining from last wakeup period, waiting to be sent to remote device.
006	Pulser B # of Pulses	Value represents twice the number of Pulser B output pulses remaining from last wakeup period, waiting to be sent to remote device.
008	Gas Pressure	Gas pressure measured at the last wake-up and used in calculating the pressure correction factor (Item 044). The pressure value is scaled to the unit of measure selected at Item 087. If the instrument is fixed factored for pressure (Item 109), this value should be manually set to the pressure used in the supercompressibility calculations, if super is active (Item 110).
010	Press High Alarm Limit	High limit for pressure, initiates alarms (Item 143), if exceeded. Default = 099999.99
011	Press Low Alarm Limit	Low limit for pressure, initiates alarms (Item 143), if exceeded. Default = -1.0
012	Atmospheric Cal Ref	Atmospheric pressure optionally entered by the instrument technician during the most recent calibration of an absolute pressure transducer. Default = 0.0000

Item No.	Item Name	Description
013	Base Pressure	Base pressure per the contract, used in calculating pressure correction factor. Default = 14.7300
014	Atmospheric Pressure	Average atmospheric pressure per the contract, used in calculating pressure correction factor (Item 044) when a gauge transducer is installed (Item 112=Gauge). This value is ignored if an absolute transducer is installed (Item 112 = Absolute). Default = 14.7300
015	Reference Press #1	The pressure value used during the most recent Pressure Zero calibration. Default = 0.00
016	Reference Press #2	The pressure value used during the most recent Pressure Span calibration. Default = 0.00
017	Press Calibration Zero	The most recent offset for the pressure transducer, obtained during a Pressure Zero calibration. The value is normally very close to 0.0000 and is recalculated during each Pressure Zero Calibration. Default = 0.0000
018	1 Prev Press Cal Zero	The previous value of Item 017, updated on each Pressure Zero Calibration. Default = 0.0000
020	Press Calibration Span	The most recent span value for the pressure transducer, obtained during a Pressure Span calibration. The value is normally very close to 1.0000 and is recalculated on each Pressure Span Calibration. Default = 1.0000
021	1 Prev Press Cal Span	The first previous pressure calibration span factor. Default = 1.0000
023	Min PCal Point Diff %	The configurable spread or difference (expressed in percent of full-scale of pressure range) required between Pressure Cal Zero and Pressure Cal Span calibration points. Default = 50.0000

Item No.	Item Name	Description
024	Excess PCal Change %	The configurable, maximum allowable change (expressed in percent of full scale of pressure range) to Pressure Zero and Pressure Span calibration points. Default = 2.0000
025	Transducer Range	The upper range limit of the installed pressure transducer, <u>always</u> expressed in PSI. Default = 100.00
026	Gas Temperature	Gas temperature measured at the last wake-up and used in calculating the temperature correction factor (Item 045). The temperature value is scaled to the unit of measure selected at Item 089. If the instrument is fixed factored for temperature (Item 111), this value should be manually set to the temperature used in the supercompressibility calculations, if super is active (Item 110). Default = 0.00
027	Gas Temp Lo Alarm Limit	Low limit for temperature, initiates alarm (Item 144) if exceeded. Default = -35.00
028	Gas Temp Hi Alarm Limit	High limit for temperature, initiates alarm (Item 146) if exceeded. Default = 145.00
029	Reference Temp#1	The temperature value used during the most recent Temperature Zero calibration. Default = 0.00
030	Reference Temp#2	The temperature value used during the most recent Temperature Span calibration. Default = 0.00
031	Case Temperature	Temperature measured inside instrument case at last wake-up. Default = 0.00
032	Case Temp Maximum	Highest case temperature measured by unit since last manual reset. Default = -40.00
033	Case Temp Minimum	Lowest case temperature measured by unit since last manual reset. Default = 099999.99

Item No.	Item Name	Description
034	Base Temperature	Base temperature per the contract, used to calculate temperature correction factor (Item 045). Default = 60.00
035	Temperature Cal Zero	The most recent offset value for the temperature transducer, obtained during a Temperature Zero calibration. The value is normally very close to 0.0000 and is recalculated during each Temperature Zero Calibration. Default = 0.0000
036	1 Prev Temp Cal Zero	The previous value of Item 035, updated on each Temperature Zero Calibration. Default = 0.0000
038	Temperature Cal Span	The most recent span value for the temperature transducer, obtained during a Temperature Span calibration. The value is normally very close to 1.0000 and is recalculated on each Temperature Span Calibration. Default = 1.0000
039	1 Prev Temp Cal Span	The previous value of Item 038, updated on each Temperature Span Calibration. Default = 1.0000
041	Min TCal Point Diff %	The configurable spread or difference (expressed in percent of full-scale of the temperature range, i.e., -40.00 to +150.00F, or 190 degrees) required between Temperature Zero and Temperature Span calibration points. Default = 10.0000
042	Excess TCal Change %	The configurable maximum allowable change (expressed in percent of full-scale of temperature range) to Temperature Zero and Temperature Span calibration points. Default = 2.0000
043	Total Correction Factor	Total correction factor calculated at the most recent wake-up and used as a multiplier to convert uncorrected volume to corrected volume. It is the product of the values at Items 044, 045, 046, and 047 (i.e., values at: $44 \times 45 \times 46 \times 47^2$) Default = 1.0000

Item No.	Item Name	Description
044	Press Correction Factor	Pressure correction factor calculated at the most recent wake-up using Boyle's Law for values at Items 008, 013, and 014 when Item 109 is set for LIVE. Items 044 and 008 may be fixed factored to any reasonable value by the user, if Item 109 is set for FIXED. Default = 1.0000
045	Temp Correction Factor	Temperature correction factor calculated at the most recent wake-up using Charles' Law for values at Items 026 and 034 when Item 111 is set for LIVE. Items 045 and 026 may be fixed factored to any reasonable value, by the user, if Item 111 is set for FIXED. Default = 1.0000
046	Aux Correction Factor	Factor to provide for other possible corrections to metered volume, i.e., Water Vapor Content, Therms, etc. If not applicable, set to 1.0000. Default = 1.0000
047	Unsquard Supercompress	NX-19 Supercompressibility factor calculated at the most recent wake-up from values at Items 008, 026, 053, 054 and 055, if Item 110 is set for LIVE. May be fixed factored to any reasonable value entered by the user, if Item 110 is set for FIXED. Default = 1.0000
048	Battery Voltage Reading	Main battery voltage measured at last wake-up. Default = 0.00
049	Battery Low Volt Limit	Low limit for main battery voltage, initiates alarm (Item 099) if voltage drops below this value. Default = 4.30
050	Shutdown Voltage Limit	The voltage level at which “..H.E.L.P.” is displayed on the LCD as an indication that the battery is about dead and needs replaced. Default = 4.00

Item No.	Item Name	Description
053	Specific Gravity for Super	Specific gravity, entered by the user, for calculating NX-19 supercompressibility factor at Item 047. Default = 0.6000
054	% N2 for Supercompress	Percentage of Nitrogen molecules, entered by the user, for calculating the NX-19 supercompressibility factor at Item 047. Default = 0.0000
055	% CO2 for Supercompress	Percentage of Carbon Dioxide molecules, entered by the user, for calculating the NX-19 supercompressibility factor at Item 047. Default = 0.0000
056	Pulser A Out Scaling	Scaling factor that determines the volume per pulse for channel A pulse outputs when Item 093 is set to CorVol or UncVol. Default =2.0000
057	Pulser B Out Scaling	Scaling factor that determines the volume per pulse for channel B pulse outputs when Item 094 is set to CorVol or UncVol. Default = 2.0000
061	Display Test	A test pattern that displays all segments and decimal points of the LCD numeric display. By default, item 061 is the first item programmed into Mag List 1. This insures that the LCD status is viewed prior to displaying item values. Example: 8.8.8.8.8.8.8
062	Serial Number	Factory assigned Instrument Serial Number. Example: 09901234. x9901234- disregard the leading zero x99xxxxx – 2 digit year of manufacture xxx01234 - 5 digit sequence number during the year of manufacture Default = 00000000
075	Mag List 2 Item 1	Item number of the first item displayed in MAG LIST #2. The display of this selection follows the display of LIVE Parameters. Any Mini-Max item number may be entered as a Mag Read Item. A value of 255 in item 075 will turn off MAG LIST #2 Default = 048 (Battery Voltage)

Item No.	Item Name	Description
076	Mag List 2 Item 2	Item number of the next Mag List #2 item. Any item code may be selected, or enter the value "255" at this item to indicate the End-of-List. Default = 255 (End-of-List)
077	Mag List 2 Item 3	Same as Item 76 above. Default = 255 (End-of-List)
078	Mag List 2 Item 4	Same as Item 76 above. Default = 255 (End-of-List)
079	Mag List 2 Item 5	Same as Item 76 above. Default = 255 (End-of-List)
080	Mag List 2 Item 6	Same as Item 76 above. Default = 255 (End-of-List)
081	Mag List 2 Item 7	Same as Item 76 above. Default = 255 (End-of-List)
082	Mag List 2 Item 8	Same as Item 76 above. Default = 255 (End-of-List)
083	Mag List 2 Item 9	Same as Item 76 above. Default = 255 (End-of-List)
084	Mag List 2 Item 10	Same as Item 76 above. Default = 255 (End-of-List)
085	Mag List 2 Item 11	Same as Item 76 above. Default = 255 (End-of-List)
086	Mag List 2 Item 12	Same as Item 76 above. Default = 255 (End-of-List)
087	Pressure Units	Code (0-9) that selects the unit of measure for Gas Pressure (008) and other pressure related items. Select: 0 - PSIG (Default) 5 - mBAR 1 - PSIA 6 - KGcm2 2 - kPa 7 - in WC 3 - mPa 8 - in HG 4 - BAR 9 - mm HG

Item No.	Item Name	Description
089	Temperature Units	Code (0-3) that selects the unit of measure for Gas Temperature (026) and other temperature related items. Select: 0 - Degrees F (Fahrenheit) (Default) 1 - Degrees C (Celsius) 2 - Degrees R (Rankine) 3 - Degrees K (Kelvin)
090	Corrected Volume Units	Code (0-20) that selects the unit of measure for Corrected Volume (Item 000) and other CorVol related items. Default = 8 (MCF). Possible selections for Items 090 and 092 are: 0 - CU FT 11 - m3 x 10 1 - CU FT x 10 12 - m3 x 100 2 - CUFT x 100 13 - m3 x 1000 3 - CF 14 - CF x 10000 4 - CF x 10 15 - THERMS 5 - CF x 100 16 - DKTHERMS 6 - CF x 1000 17 - MJOULES 7 - CCF 18 - GJOULES 8 - MCF 19 - KILOCAL 9 - m3 x 0.1 20 - KILOWATHR 10 - m3
		To properly use selections 15 - 20 at item 090, the appropriate energy factor must be manually placed into item 142 (Gas Energy Value).
092	Uncorrected Volume Units	Code (0-20) that selects the unit of measure for Uncorrected Volume (Item 002) and other UncVol related items, except Instrument Dial Rate (Item 218) which is always expressed in cubic feet per hour. Default = 7 (CCF). Possible selections for Items 090 and 092 are: 0 - CU FT 11 - m3 x 10 1 - CU FT x 10 12 - m3 x 100 2 - CUFT x 100 13 - m3 x 1000 3 - CF 14 - CF x 10000 4 - CF x 10 15 - THERMS 5 - CF x 100 16 - DKTHERMS 6 - CF x 1000 17 - MJOULES 7 - CCF 18 - GJOULES 8 - MCF 19 - KILOCAL 9 - m3 x 0.1 20 - KILOWATHR 10 - m3
		To properly use selections 15 - 20 at item 092, the appropriate energy factor must be manually placed into item 142 (Gas Energy Value).

Item No.	Item Name	Description												
093	Pulser A Out Select	<p>Code (0-4) that selects the type of pulse information to be transmitted out Pulser Channel A.</p> <p>Possible selections are:</p> <ul style="list-style-type: none"> 0 - COR VOL 1 - Not Used 2 - UNC VOL 3 - NO OUTPUT (Default) 4 - TIME 												
094	Pulser B Out Select	<p>Code (0-4) that selects the type of pulse information to be transmitted out Pulser Channel B.</p> <p>Possible selections are:</p> <ul style="list-style-type: none"> 0 - COR VOL 1 - Not Used 2 - UNC VOL 3 - NO OUTPUT (Default) 4 - TIME 												
096	Cor Vol Display Res	<p>Code (0-4) that selects the number of digits (out of eight) to be displayed when the corrected volume (Item 000) is displayed.</p> <p>Default = 0</p> <table border="0" style="margin-left: 40px;"> <tr> <td></td> <td style="text-align: right;">Example:</td> </tr> <tr> <td>Select: 0 - 8 DIGITS</td> <td style="text-align: right;">12345678</td> </tr> <tr> <td>1 - 7 DIGITS</td> <td style="text-align: right;">2345678</td> </tr> <tr> <td>2 - 6 DIGITS</td> <td style="text-align: right;">345678</td> </tr> <tr> <td>3 - 5 DIGITS</td> <td style="text-align: right;">45678</td> </tr> <tr> <td>4 - 4 DIGITS</td> <td style="text-align: right;">5678</td> </tr> </table>		Example:	Select: 0 - 8 DIGITS	12345678	1 - 7 DIGITS	2345678	2 - 6 DIGITS	345678	3 - 5 DIGITS	45678	4 - 4 DIGITS	5678
	Example:													
Select: 0 - 8 DIGITS	12345678													
1 - 7 DIGITS	2345678													
2 - 6 DIGITS	345678													
3 - 5 DIGITS	45678													
4 - 4 DIGITS	5678													
097	Unc Vol Display Res	<p>Code (0-4) that selects the number of digits (out of eight) to be displayed when the uncorrected volume (Item 002) is displayed.</p> <p>Default = 0.</p> <table border="0" style="margin-left: 40px;"> <tr> <td></td> <td style="text-align: right;">Example:</td> </tr> <tr> <td>Select: 0 - 8 DIGITS</td> <td style="text-align: right;">12345678</td> </tr> <tr> <td>1 - 7 DIGITS</td> <td style="text-align: right;">2345678</td> </tr> <tr> <td>2 - 6 DIGITS</td> <td style="text-align: right;">345678</td> </tr> <tr> <td>3 - 5 DIGITS</td> <td style="text-align: right;">45678</td> </tr> <tr> <td>4 - 4 DIGITS</td> <td style="text-align: right;">5678</td> </tr> </table>		Example:	Select: 0 - 8 DIGITS	12345678	1 - 7 DIGITS	2345678	2 - 6 DIGITS	345678	3 - 5 DIGITS	45678	4 - 4 DIGITS	5678
	Example:													
Select: 0 - 8 DIGITS	12345678													
1 - 7 DIGITS	2345678													
2 - 6 DIGITS	345678													
3 - 5 DIGITS	45678													
4 - 4 DIGITS	5678													

Item**No. Item Name****Description**

098 Meter Index Code

Code (0-8) that selects the value of each uncorrected input pulse. The selection should agree with the gas meter drive rate, i.e., the amount of uncorrected volume per output shaft rotation (or meter pulse).

Select: 0 - 1 CF

1 - 5 CF

2 - 10 CF (**Default**)

3 - 100 CF

4 - 1000 CF

5 - .1m³

6 - 1 m³

7 - 10 m³

8 - 100 m³

099 Battery Low Volt Alarm

This item indicates if a low voltage alarm for the main battery was generated. During a wake-cycle, if the measurement for Item 048 (BATTERY VOLTAGE) is a value less than the value at Item 049 (BATTERY LOLIM V), an alarm is initiated and is indicated by placing dots on the LCD and “1111111” at Item 099. “00000000” at Item 099 indicates there is no Low Battery Alarm. The alarm indicators will remain active until cleared manually (by software) or automatically when the batteries are replaced.

Default = 00000000

102 Index SW#1 Fault Alarm

This item indicates if an alarm for index switch #1 was generated. If index switch #1 fails to provide an input meter pulse within four meter revolutions, an alarm is initiated and is indicated by placing dots on the LCD and “1111111” at Item 102. “00000000” at item 102 “00000000” at Item 102 indicates there is no switch #1 alarm. The alarm indicators will remain active until manually cleared (by software).

Default = 00000000

103 Index SW#2 Fault Alarm

This item indicates if an alarm for index switch #2 was generated. If index switch #2 fails to provide an input meter pulse within four meter revolutions, an alarm is initiated and is indicated by placing dots on the LCD and “1111111” at Item 103. “00000000” at Item 103 indicates there is no switch #2 alarm. The alarm indicators will remain active until manually cleared (by software).

Default = 00000000

Item No.	Item Name	Description
104	A/D Fault	<p>This item indicates if an alarm for the A/D Converter was generated. If the microprocessor detects an A/D fault (Analog to Digital), an alarm is initiated and is indicated by placing dots on the LCD and “1111111” at Item 104. “00000000” at Item 104 indicates there is no A/D Converter Alarm. The alarm indicators will remain active until manually cleared (by software). Unlike other instrument alarms, an A/D Fault is usually a hardware failure which requires factory replacement of a component on the main circuit board, or a field replacement of the main board.</p> <p>Default = 00000000</p>
108	Alarms Output	<p>This item displays “1111111” to indicate that a standard alarm (099, 102-104, 143-146, or 222) has become active, and that an alarm pulse was transmitted out the Alarm Channel. “00000000” at Item 108 indicates there are no active alarms.</p> <p>Default = 00000000</p>
109	Fixed Pressure Factor	<p>Code (0-1) that selects Live or Fixed Factor Pressure. When enabled for Fixed Factor, the Pressure Factor entered at Item 044 will be used for pressure correction instead of a Live Pressure factor calculation based on the input from the pressure transducer. NOTE: If Item 109 is “Fixed”, a value MUST be entered at Item 044. It may also be necessary to enter a value at Item 008 (Gas Pressure) if Supercompressibility (Item 110) is “Live.”</p> <p>Select: 0 - No Fixed Factor (Live) (Default) 1 - Fixed Factor</p>
110	Fixed Super Factor	<p>Code (0-1) that selects Live or Fixed Supercompressibility. When enabled for Fixed Super, the unsquared super factor entered at Item 047 will be used for supercompressibility correction, instead of a live super calculation. Note: If Item 110 is “Fixed”, a value must be entered at Item 047. Entering a fixed Super value of “1.0000” will essentially disable the Supercompressibility function.</p> <p>Select: 0 - No Fixed Factor (Live) (Default) 1 - Fixed Factor</p>

Item No.	Item Name	Description
111	Fixed Temp Factor	<p>Code (0-2) that selects Live or Fixed Factor Temperature. When enabled for Fixed Factor (code 1), the Temperature Factor entered at Item 045 will be used for temperature correction, instead of a live calculation based on the input from the temperature probe. Note: If Item 111 is “Fixed”, a value must be entered at Item 045. It may also be necessary to enter a value at Item 026 (Gas Temperature) if supercompressibility is “Live.” If the selection for Item 111 is code 2 (Super), the total correction factor will include the value entered at Item 045 (usually 1.0000), while using the Live gas temperature from the temperature probe for the supercompressibility calculation. The code 2 selection was made available for sites with TC meters.</p> <p>Select: 0 - No Fixed Factor (Live) (Default) 1 - Fixed Factor 2 - Fixed Factor with Live Measured Temperature Used for Supercompressibility Computations.</p>
112	Transducer Type	<p>Code (0 or 1) to indicate the type of pressure transducer installed. Since the equations to calculate pressure correction and supercompressibility are dependent upon the transducer type, make sure the selection at Items 087 and 112 are properly configured for the installed transducer.</p> <p>Select: 0 – Gauge (Default) 1 - Absolute</p>
113	High Resolution CorVol	<p>Display of the fractional portion (to the 4th decimal) of item 000 (Totalized Corrected Volume) with the last three CorVol integers for reference. Example: if the value at item 000 equals “12345678 MCF” item 113 may appear as “678.2477 MCF”. The four decimal places are useful during field calibration checks when using a small number of meter revolutions.</p> <p>Default = 000.0000</p>
114	Meter Scaling	<p>Scaling factor for uncorrected volume input (Item 002) applied to the value selected at Item 098 (Meter Index Code). Usually used if the volume input is a value other than 0.1, 1, 5, 10, 100, or 1000.</p> <p>Default = 1.0000</p>

Item No.	Item Name	Description
115	Output Pulse Code	Code (0-4) to provide slower pulse rates for remote counter/readout devices, requiring more time to process the volume pulses. The coded value represents the pulse width in milliseconds. The pulse-on time is half of the pulse cycle. The standard pulse-on time for a Form-A output is 62.5 milliseconds. Form A Select: 0 - 0.0625 Default 1 – 0.500 2 – 1.000 3 – 0.125 4 - 0.250
116	Squared Supercompress	Supercompressibility factor squared (Fpv) ² , i.e., the square of the value at item 47. The value at item 116 is one of the factors used to obtain total correction factor (item 43). Default = 1.0000
120	Pressure Cal Date	Date of the most recent change of Pressure Cal Zero (Item 017). The date is automatically inserted into Item 120 when exiting the Pressure Zero calibration function. Default = 01-01-99
121	Temperature Cal Date	Date of the most recent change to Temperature Cal Zero (Item 035). The date is automatically inserted into Item 121 when exiting the Temperature Zero calibration function. Default = 01-01-99
122	Firmware	This item is used to display the instrument's operating firmware version number. The number reported is automatically inserted when a firmware file is uploaded into FLASH memory.
124	Revolutions Per Wakeup	This parameter (N) is used to determine the number of meter revolutions required before a full wake-up is initiated and new analog measurements are taken. All other meter revolutions will result in intermediate wake-ups. This function is a carry-over from the ECAT/Mini as a power conservation feature on fast meters having fairly constant pressures and temperatures. The significance of this feature in the Mini-Max is less since the power drain on the battery is less. Range: 1 to 15 Default = 1

Item No.	Item Name	Description
126	Instrument Baud Rate	<p>Code (0-8) to select the instrument’s baud rate for a local serial connection. If Autobaud is selected, the instrument will connect to the computer at the baud rate the software is set to communicate at. If any other selection is made, the computer baud rate must match that of the instrument to communicate.</p> <p>Select: 0-9600 5-Not Used 1-4800 6-19200 2-2400 7-38400 3-1200 8-AutoBaud - Default 4-Not Used</p>
128	Mag Alarm Acknowledge	<p>Code (0 or 1) to enable or disable the clearing of all active alarms using the MI button. During the Meter Reader List, an “E.E.E.E.E.E.E” display will appear after scrolling through all active alarms. Allowing the instrument to time out (1-minute) at this display will clear all alarms. If the MI button is pressed before the “E.E.E.E.E.E.E” display times out, the alarms are not cleared. This feature is most useful if alarms need to be cleared and a laptop computer is not available. If item 128 is configured for “Disabled” the “E.E.E.E.E.E.E” will not be displayed.</p> <p>Select: 0 - Disabled 1 - Enabled - Default</p>
129	Live Display Enable	<p>Code (0 - 11) to select the display of live gas pressure and/or live temperature and/or dial rate as part of the Meter Reader List. If enabled, the live parameter(s) will appear after the display of the last Mag List 1, but before any Mag List 2 items. Live gas pressure, temperature and dial rate have a 10 minute time-out instead of the usual 1 minute.</p> <p>Select: 0 - None 2 - Live T 1 - Live P 3 - Live P & T Default 8 - Live Dial Rate 9 - Live P & Dial Rate 10 - Live T & D. Rate 11 - Live P, T & D.R.</p>
130	Mag List 1 Item 1	<p>Item number of the first item displayed in the Meter Reader List, unless there are active alarms. Active alarms are always displayed prior to the selected mag list items. Any Mini-Max item may be entered as a mag list item. Enter a 255 for this item if the Mag List 1 function is to be disabled. See the section on using the Meter Reader List for more information.</p> <p>Default = 061 (Display Test)</p>

Item No.	Item Name	Description
131	Mag List 1 Item 2	Item number of the second Mag List 1 item. Any Mini-Max item may be entered. Enter a 255 at this item to indicate the End-of-List for Mag List 1. Default = 002 (Uncorrected Volume)
132	Mag List 1 Item 3	Item number of the third Mag List 1 item. Any Mini-Max item may be entered. Enter a 255 at this item to indicate the End-of-List for Mag List 1. Default = 000 (Corrected Volume)
133	Mag List 1 Item 4	Item number of the fourth Mag List 1 item. Any Mini-Max item may be entered. Enter a 255 at this item to indicate the End-of-List for Mag List 1. Default = 255 (End-of-List)
134	Mag List 1 Item 5	Item number of the fifth Mag List 1 item. Any Mini-Max item may be entered. Enter a 255 at this item to indicate the End-of-List for Mag List 1. Default = 255 (End-of-List)
135	Mag List 1 Item 6	Item number of the sixth Mag List 1 item. Any Mini-Max item may be entered. Enter a 255 at this item to indicate the End-of-List for Mag List 1. Default = 255 (End-of-List)
137	Xducer Range	The upper pressure range limit, automatically scaled to the pressure units selected at Item 087. If PSI is the selected pressure units, then Item 137 will be the same as Item 025. NOTE: The value at Item 137 may be manually edited to a rounded-off number, if desired. Default = 100.00
138	Transducer Serial#	Serial number of the pressure transducer (printed on the transducer label), manually inserted at the factory. Note: Forcing factory defaults will not change the value of this item. Default = 00000000
140	Energy	The totalized gas energy, equivalent to the totalized corrected volume (item 000) multiplied by the Gas Energy Value (item 142) and updated every correction cycle. Default = 00000000

Item No.	Item Name	Description
141	Energy Units	<p>The code (0 - 5) that selects the unit of measure for Energy (140). Select: 0 - THERMS ---Default 3 - GJOULES 1 - DKTHERMS 4 - KILOCAL 2 - MJOULES 5 - KILOWATTHR</p>
142	Gas Energy Value	<p>User-provided value to indicate the amount of energy contained in each volumetric unit of corrected volume. This value is a multiplier used to calculate Energy at item 140. The nominal Gas Energy Values for the various Energy Units (item 141) are listed below:</p> <p style="padding-left: 40px;"> THERMS - 1000 BTU per CuFt of gas Default DKTHERMS - 1000 BTU per CuFt of gas MJOULES - 37259.00 Kilojoules per m3 of gas GJOULES - 37259.00 Kilojoules per m3 of gas KILOCAL - 8905.00 Kilocalories per m3 of gas KILOWATTHR - 10349.73 Watt/Hr per m3 of gas </p>
143	Pressure Low Alarm	<p>This item indicates if a low pressure alarm was generated. During a wake cycle, if the measurement for Item 008 (GAS PRESSURE) is a value less than the value entered at Item 011 (PRESS LOLIM), an alarm is initiated and is indicated by placing dots on the LCD and “1111111” at Item 143. “00000000” at Item 143 indicates there is no Pressure Low Alarm. The alarm indicators will remain active until manually cleared (by software). The Pressure Low Limit value (Item 011) is user selectable and is normally set somewhere between 0 and 50% of transducer range.</p> <p style="text-align: center;">Default = 00000000</p>
144	Temperature Low Alarm	<p>This item indicates if a low temperature alarm was generated. During a wake cycle, if the measurement for Item 026 (GAS TEMPERATURE) is a value less than the value entered at Item 027 (TEMP LOLIM), an alarm is initiated and is indicated by placing dots on the LCD and “1111111” at Item 144. “00000000” at Item 144 indicates there is no Temperature Low Alarm. The alarm indicators will remain active until manually cleared (by software). The Temperature Low Limit value (Item 027) is user selectable and is normally set somewhere between 0 and 50% of transducer range.</p> <p style="text-align: center;">Default = 00000000</p>

Item No.	Item Name	Description
145	Pressure High Alarm	<p>This item indicates if a high pressure alarm was generated. During a wake cycle, if the measurement for Item 008 (GAS PRESSURE) is a value greater than the value entered at Item 010 (PRES HILIM), an alarm is initiated and is indicated by placing dots on the LCD and “1111111” at Item 145. “00000000” at item 145 indicates there is no Pressure High Alarm. The alarm indicators will remain active until manually cleared (by software). The Pressure High Limit value (Item 010) is user selectable and is normally set somewhere between 50 and 100% of transducer range.</p> <p style="text-align: center;">Default = 00000000</p>
146	Temperature High Alarm	<p>This item indicates if a high temperature alarm was generated. During a wake cycle, if the measurement for Item 026 (GAS TEMPERATURE) is a value greater than the value entered at Item 028 (TEMP HILIM), an alarm is initiated and is indicated by placing dots on the LCD and “1111111” at Item 146. “00000000” at Item 146 indicates there is no Temperature High Alarm. The alarm indicators will remain active until manually cleared (by software). The Temperature High Limit value (Item 028) is user selectable and is normally set somewhere between 50 and 100% of transducer range.</p> <p style="text-align: center;">Default = 00000000</p>
147	Compress Type	<p>Selection to allow the user to choose the type of gas compressibility calculation employed during each correction cycle wake-up. Selection “0” (NX-19) results in the implementation of AGA-3 / NX-19 Supercompressibility calculations. Selection “1” (AGA-8) results in the implementation of AGA-8 calculations.</p> <p style="text-align: center;">Select: 0 - NX-19---Default 1 - AGA-8 (Mini-Max-AT or ATX Only)</p>
148	Incremental Energy	<p>Same as item 140 (Energy) but is initialized to 00000000 after every TIME log-trigger (item 202). If interrogated, the value displayed indicates the most recently logged value.</p> <p style="text-align: center;">Default = 00000000</p>

Item No.	Item Name	Description
170	Protocol Code A	<p>Select (0-1) to determine if a specific Mercury Protocol error code is transmitted while attempting a serial link sign-on. When this function is set to “0”, (which is the recommended setting for most applications) all instrument error codes are transmitted as in previous versions of firmware. When this item is set to “1”, the MINI-MAX will not send time-out errors during serial communications. The selection of “1” is provided as a convenience for some 3rd party communication interfaces.</p> <p>Select: 0 – Standard (Default) 1 – No Time-out Error</p>
171	Timeout Delay 1	<p>The time (in seconds) the MINI-MAX waits for the host computer to send the protocol control character “ENQ” during instrument sign-on before issuing an error “21” (timeout error). This function is provided as a convenience for some 3rd party communication interfaces and under most situations, should not be changed from the default setting. Range: 7 to 60, Default = 7</p>
172	Timeout Delay 2	<p>The time (in seconds) the MINI-MAX waits for the host computer to send the protocol control character “ENQ” during instrument sign-on before issuing an error “21” (timeout error). This function is provided as a convenience for some 3rd party communication interfaces and under most situations, should not be changed from the default setting. Range: 7 to 60, Default = 7</p>
178	P Comp Coefficient A	Pressure compensation coefficient that accounts for changes in temperature.
179	P Comp Coefficient B	Same as item 178 above
180	P Comp Coefficient C	Same as item 178 above
181	P Comp Coefficient D	Same as item 178 above
183	Previous Day Cor Vol	<p>Yesterday’s Daily Corrected Volume, i.e., the daily-corrected volume that is one GAS DAY old at the time the instrument is accessed. This information is updated with the value at Item 223 at the beginning of every new gas day. Note: The gas day begins at the time entered at Item 205.</p> <p>Default = 00000000</p>

Item No.	Item Name	Description
184	Previous Day Unc Vol	<p>Yesterday's Daily Uncorrected Volume, i.e., the daily uncorrected volume that is one GAS DAY old at the time the instrument is accessed. This information is updated with the value at Item 224 at the beginning of every new gas day. Note: The gas day begins at the time entered at Item 205.</p> <p>Default = 00000000</p>
185	Previous Day Avg Press	<p>Yesterday's Daily Average Pressure (expressed in the pressure units selected at Item 087), i.e., the daily average pressure that is one GAS DAY old at the time the instrument is accessed. This information is updated with the value at Item 256 at the beginning of every new gas day. The gas day begins at the time entered at Item 205.</p> <p>Default = 0.00</p>
186	Previous Day Avg Temp	<p>Yesterday's Daily Average Temperature, i.e., the daily average temperature that is one GAS DAY old at the time the instrument is accessed. This information is updated with the value at Item 257 at the beginning of every new gas day. The gas day begins at the time entered at Item 205.</p> <p>Default = 0.00</p>
188	Daily Avg Unsq Super	<p>This value is the average Unsquared Supercompressibility Factor for the current Gas Day. This is a running average, which is zeroed and begins a new calculation at the time entered at Item 205. Therefore, the value displayed during instrument access is the most recent calculated value for the current gas day.</p> <p>Default = 1.0000</p>
189	Prev Day Avg Unsq Super	<p>Yesterday's Daily Unsquared Supercompressibility Factor, i.e., the daily unsquared supercompressibility factor that is one GAS DAY old at the time the instrument was accessed. This item is updated with the value from Item 188 at the beginning of every new gas day. Note: The gas day begins at the time entered at Item 205.</p> <p>Default = 1.0000</p>
190	Daily Energy	<p>Same as item 140 (Energy), except this value is the running total for the current Gas Day, which is zeroed and begins a new calculation at the time entered at item 205. Therefore, the value displayed during instrument access is the most recent calculated value for the current gas day.</p> <p>Default = 00000000</p>

Item No.	Item Name	Description
191	Previous Day Energy	<p>Yesterday's Daily Energy, i.e., the daily energy that is one 'Gas Day' old at the time the instrument was accessed. This information is updated with the value from item 190 at the beginning of every new gas day. Note: The gas day begins at the time entered at item 205.</p> <p>Default = 00000000</p>
200	Site ID Number	<p>User assigned, eight digit numeric site number. Limited to characters: 0-9. The "." and "-" are not valid characters. Note: All instruments downloaded using Mercury Instruments Window-based software must be configured for unique Site ID Numbers at Items 200 and 201.</p> <p>Default = 00000000</p>
201	Site ID Number Part 2	<p>Eight additional digits for the site number, if needed. Note: All instruments downloaded using Mercury Instruments Windows-based software must be configured for unique Site ID Numbers at Items 200 and 201.</p> <p>Default = 00000000</p>
202	Log Interval	<p>User selected time period that determines how often a time-stamp record is placed in audit trail memory.</p> <p>Select: 60 (minutes) 24 (hours) Default</p>
203	Time	<p>Real Time Clock that displays hours, minutes, and seconds in 24-hour "military" time, i.e., 14:30:02 would be 2 seconds past 2:30 PM. Leading zeros are required where applicable.</p> <p>Default = 12:00:00</p>
204	Date	<p>A numeric field indicating either Month-Day-Year (MM-DD-YY), Day-Month-Year (DD-MM-YY), or Year-Month-Day (YY-MM-DD), depending on the Date Format selection at Item 262. The Date automatically tracks the days in the month, including leap year. Leading zeros are required where applicable. This Date (and Time, Item 203) is used to time-stamp records in Audit Trail.</p> <p>Default = 01-01-99, Format: MM-DD-YY</p>
205	Start Time	<p>User selectable time to begin the start of the GAS DAY, which by definition of other items, is the time of day when daily computations are re-zeroed to begin the next day's computations. Note: The time entered should contain zeros for minutes and zeros for seconds.</p> <p>Default = 08 00 00</p>

Item No.	Item Name	Description
206	Interval Average Pressure	<p>Calculated average pressure for the time interval selected at item 202. The average value is ‘flow weighted’, meaning the only pressure measurements included are obtained at the time of uncorrected volume inputs. This relates exactly to the correction factors and is the equivalent of a pressure trace on a meter-driven volume chart. The average pressure is a running average, so the value displayed is the most recent value calculated.</p> <p>Default = 0.00</p>
207	Interval Average Temperature	<p>Calculated average temperature for the time interval selected at item 202. The average value is ‘flow weighted’, meaning the only temperature measurements included are obtained at the time of uncorrected volume inputs. This relates exactly to the correction factors and is the equivalent of a temperature trace on a meter-driven volume chart. The average temperature is a running average, so the value displayed is the most recent value calculated.</p> <p>Default = 0.00</p>
209	Inst Flow Rate	<p>The current instantaneous rate of flow for Corrected Volume (000), expressed in the selected CORVOL units (Item 090) per hour. The value is equal to the most recent increment of CORVOL, divided by the length of time between the last two correction cycles. (The minimum acceptable time between correction cycles is one minute.) If the meter is rotating faster than 1 RPM, the calculation is delayed until the time is equal to, or greater than, one minute. When accessed, the unit will display the most recently computed value.</p> <p>Default = 0.00</p>
214	Interval High Pressure	<p>Highest Gas Pressure (item 008) measured during the time interval selected at item 202. The value at item 214 is initialized (re-zeroed) at the beginning of each new log interval.</p> <p>Default = 0.00</p>
215	Interval LO Pressure	<p>Lowest PCor Gas Pressure (item 008) measured during the Time interval selected at item 202. The value at item 214 is initialized (re-zeroed) at the beginning of each new log interval.</p> <p>Default = 099999.99</p>

Item No.	Item Name	Description
216	Interval High Temp	Highest Gas Temperature (item 026) measured during the time interval selected at item 202. The value at item 216 is initialized (re-zeroed) at the beginning of each new log interval. Default = 0.00
217	Interval LO Temp	Lowest Gas Temperature (item 026) measured during the Time interval selected at item 202. The value at item 214 is initialized (re-zeroed) at the beginning of each new log interval. Default = 099999.99
218	Inst Dial Rate	“Instantaneous” meter clock rate derived from the UNCVOL meter pulses and expressed in Cubic Feet per hour or Cubic Meters per hour (depending on the selection at Item 098). Similar to INST FLOW RATE (Item 209), including the 1 minute time limitation. Default = 0
221	Daily Cor Vol Alrm Limit	The high limit value for daily contract volume, initiates an alarm (Item 222). Default = 99999999
222	Daily Cor Vol Alarm	During a wake cycle, if the computed value for Item 223 (DAILY CORVOL) is greater than the value at Item 221 (DAILY CORVOL LIMIT), an alarm is initiated and is indicated by placing dots on the LCD and “1111111” at Item 222. “00000000” at Item 222 indicates there is no Daily CorVol Alarm. The alarm and alarm indicators are automatically cleared at the beginning of each Gas Day. Default = 00000000
223	Daily Cor Vol	Same as CORVOL (Item 000) but is initialized (re-zeroed) at START TIME (Item 205) each Gas Day. If the instrument is accessed, this item will display the current value for that point in time. Default = 00000000
224	Daily Unc Vol	Same as UNCVOL (Item 002) but is initialized (re-zeroed) at START TIME (Item 205) each Gas Day. If the instrument is accessed, this item will display the current value for that point in time. Default = 00000000

Item No.	Item Name	Description
225	Incremental Cor Vol	Same as CORVOL (item 000) but is initialized (re-zeroed) at the beginning of every Mini-Max interval (1 day). If the instrument is accessed, this item will display the current value for that point in time. Default = 00000000
226	Incremental Unc Vol	Same as UNCVOL (item 002) but is initialized (re-zeroed) at the beginning of every Mini-Max interval (1 day). If the instrument is accessed, this item will display the current value for that point in time. Default = 00000000
243	Month Peak Hour Cor Vol	The highest hourly CORVOL of the current 'Gas' month. Default = 00000000
244	Month Peak Hour Date	The date the current month Peak Hour CORVOL (243) occurred. Format: Determined by item 262 Default = 01-01-98
245	Month Peak Hour Time	Ending hour for the current month Peak Hour CORVOL Date (244). Default = 00 00 00
246	Month Peak Day Cor Vol	The highest Daily CORVOL (item 223) of the current 'Gas' month. Default = 00000000
247	Month Peak Day Date	The date the current month Peak Day CORVOL (245) occurred. Format: Determined by item 262 Default = 01-01-98
248	Prev Mo Pk Hour Cor Vol	The highest hourly CORVOL of the previous 'Gas' month. Default = 00000000
249	Prev Mo Pk Hour Date	The date the previous month Peak Hour CORVOL (248) occurred. Format: Determined by item 262 Default = 01-01-98
250	Prev Mo Pk Hour Time	Ending hour for the previous month Peak Hour CORVOL Date (249). Default = 00 00 00
251	Prev Mo Pk Day Cor Vol	The highest Daily CORVOL (item 223) of the previous 'Gas' month. Default = 00000000

Item No.	Item Name	Description
252	Prev Mo Pk Day Date	The date the previous month Peak Day CORVOL (251) occurred. Format: Determined by item 262 Default = 01-01-98
253	Max Day Cor Vol	The highest Daily CORVOL (item 223) since last manually reset. Default = 00000000
254	Max Day Date	The date the MAX DAY CORVOL (253) occurred. Format: Determined by item 262 Default = 01-01-98
256	Daily Average Pressure	The daily average of Gas Pressure (Item 008) that will be reset to zero at the start of each Gas Day. Default = 0.00
257	Daily Average Temperature	The daily average of Gas Temperature (026) that will be reset to zero at the start of each Gas Day. Default = 0.00
258	Selectable Report Item 1	The first of four user selectable Audit Trail Report Items that can be configured for Audit Trail memory. To use these four items, insert the desired item code number into any of the report locations (258 - 261). The value "255" at any of these Report Items will cause that position to be 'blank'. The Audit Trail logger can be configured to record four item values in each audit trail record. Default: 225 (Incremental CorVol)
259	Selectable Report Item 2	See above. Default: 226 (Incremental UnVol)
260	Selectable Report Item 3	See above. Default: 206 (Interval Avg. Pressure)
261	Selectable Report Item 4	See above. Default: 207 (Interval Avg. Temp.)
262	Date Format	Code (0-2) selects the format in which the Date is entered and displayed at Item 204. The format for all date related items will also be governed by the selection of Item 262. Select: 0 - MM-DD-YY (Default) 1 - DD-MM-YY 2 - YY-MM-DD

Item No.	Item Name	Description
281	Maximum Dial Rate	The highest value of Inst Dial Rate (Item 218) since the last manual reset. Default = 0
282	Maximum Dial Rate Time	The time when Max Dial Rate (Item 281) occurred. Default = 00 00 00, Format: HH:MM:SS
283	Maximum Dial Rate Date	The date when Max Dial Rate (Item 281) occurred. Default =01-01-99, Format: MM-DD-YY
284	Maximum Dial Rate Press	The Gas Pressure (Item 008) when the Max Dial Rate (Item 281) occurred. Default = 0.00
285	Maximum Pressure	The highest value of Gas Pressure (Item 008) since the last manual reset. Default = 0.00
286	Maximum Pressure Time	The time when Max Press (Item 285) occurred. Default = 00 00 00, Format: HH:MM:SS
287	Maximum Pressure Date	The date when Max Press (Item 285) occurred. Default = 01-01-99, Format: MM-DD-YY
288	Max Press Flow Rate	The Inst Flow Rate (Item 209) when the Max Press (Item 285) occurred. Default = 0.00
289	Minimum Pressure	The lowest value of Gas Pressure (Item 008) since the last manual reset. Default = 99999.99
290	Minimum Pressure Time	The time when Min Press (Item 289) occurred. Default = 00 00 00, Format: HH:MM:SS
291	Minimum Pressure Date	The date when Min Press (Item 289) occurred. Default = 01-01-99, Format: MM-DD-YY
292	Min Press Flow Rate	The Inst Flow Rate (Item 209) when the Min Press (Item 289) occurred. Default = 0.00
293	Maximum Gas Temp	The highest value of Gas Temperature (Item 026) since the last manual reset. Default = -40.00

Item No.	Item Name	Description
294	Maximum Gas Temp Time	The time when the Max Gas Temp (Item 293) occurred. Default = 00 00 00, Format: HH:MM:SS
295	Maximum Gas Temp Date	The date when the Max Gas Temp (Item 293) occurred. Default = 01-01-99, Format: MM-DD-YY
296	Max Gas Temp Flow Rate	The Inst Flow Rate (Item 209) when the Max Gas Temp (Item 293) occurred. Default = 0.00
297	Minimum Gas Temp	The lowest value of Gas Temperature (Item 026) since the last manual reset. Default = 99999.99
298	Minimum Gas Temp Time	The time when the Min Gas Temp (Item 297) occurred. Default = 00 00 00, Format: HH:MM:SS
299	Minimum Gas Temp Date	The date when the Min Gas Temp (Item 297) occurred. Default = 01-01-99, Format: MM-DD-YY
300	Min Gas Temp Flow Rate	The Inst Flow Rate (Item 209) when the Min Gas Temp (Item 297) occurred. Default = 0.00

Item No.	Item Name	Description
301	PComp Coefficient1	Default = 0.000000
302	PComp Coefficient2	Default = 30.00000
303	PComp Coefficient3	Default = 0.000000
304	PComp Coefficient4	Default = 0.000000
305	PComp Coefficient5	Default = 0.000000
306	PComp Coefficient6	Default = 30.00000
307	PComp Coefficient7	Default = 0.000000
308	PComp Coefficient8	Default = 0.000000
309	PComp Coefficient9	Default = 0.000000
310	PComp Coefficient10	Default = 30.00000
311	PComp Coefficient11	Default = 0.000000
312	PComp Coefficient12	Default = 0.000000
313	PComp Coefficient13	Default = 0.000000
314	PComp Coefficient14	Default = 30.00000
315	PComp Coefficient15	Default = 0.000000
316	PComp Coefficient16	Default = 0.000000
317	PComp Coefficient17	Default = 0.000000
318	PComp Coefficient18	Default = 30.00000
319	PComp Coefficient19	Default = 0.000000
320	PComp Coefficient20	Default = 0.000000
321	PComp Coefficient21	Default = 0.000000
322	PComp Coefficient22	Default = 30.00000
323	PComp Coefficient23	Default = 0.000000
324	PComp Coefficient24	Default = 0.000000
325	PComp Coefficient25	Default = 0.000000
326	PComp Coefficient26	Default = 30.00000
327	PComp Coefficient27	Default = 0.000000
328	PComp Coefficient28	Default = 0.000000
329	PComp Coefficient29	Default = 0.000000
330	PComp Coefficient30	Default = 30.00000
331	PComp Coefficient31	Default = 0.000000
332	PComp Coefficient32	Default = 0.000000

Item codes 301 through 332 are the 32 pressure transducer compensation coefficients. These values determine the pressure response over the entire operating temperature range and are unique for each pressure transducer, regardless of the pressure range. The coefficient values are determined by Mercury Instruments at the factory.

Note: A MINI-MAX will **not** measure pressure accurately if the default coefficients are used.

Item No.	Item Name	Description
333	Call-In Trigger	Selection to determine what activity will cause an instrument call-in. Select: 0 - No Call-in 1 - Alarm Call-in only Default 2 - Scheduled Call-in only 3 - Alarm & Scheduled Call-In
334	Scheduled Call-In Date	Date of next scheduled call-in. This must be reset by the host software after each call. Default = 01-01-00
335	Scheduled Call-In Time	Time of next scheduled call-in. Can be reset by host software or reused for next call-in. Default = 01:00:00
338	Scheduled Call-In Alarm	Status of scheduled call-in activity. '1111111' indicates call-in activity since last interrogation and intended to be reset to zero after each read. '00000000' indicates no activity since last interrogation. Default = 00000000
339	Scheduled Call-In Phone #	Phone number used for scheduled call-in.
340	Digi-Span Mode	Selection to determine what mode the Mini-Max pulse output channels are set to. 0 = No Digi-Span (Standard Pulse Out) Default 1 = Gas Override (Pulse Channel A on) 2 = Oil Override (Pulse Channel B on) 3 = Automatic (Both Channels off)
462	Batt Low Alarm Time	The Time when the BATTERY LOW Alarm Occurred (Item 099). Default = 00:00:00 (Format: HH:MM:SS)
463	Batt Low Alarm Date	The Date when the BATTERY LOW Alarm occurred (Item 099). Date Format: Determined by Item 262. Default: 01-01-99
464	Index SW1 Alarm Time	The Time when the INDEX SW#1 FAULT Alarm occurred (Item 102). Default = 00:00:00 (Format: HH:MM:SS)

Item No.	Item Name	Description
465	Index SW1 Alarm Date	The Date when the INDEX SW#1 FAULT Alarm occurred (Item 102). Date Format: Determined by Item 262. Default: 01-01-99
466	Index SW2 Alarm Time	The Time when the INDEX SW#2 FAULT Alarm Occurred (Item 103) Default = 00:00:00 (Format: HH:MM:SS)
467	Index SW2 Alarm Date	The Date when the INDEX SW#2 FAULT Alarm occurred (Item 103). Date Format: Determined by Item 262. Default: 01-01-99
468	A/D Fault Alarm Time	The Time when the A/D FAULT Alarm occurred (Item 104). Default = 00:00:00 (Format: HH:MM:SS)
469	A/D Fault Alarm Date	The Date when the A/D FAULT Alarm occurred (Item 104). Date Format: Determined by Item 262. Default: 01-01-99.
470	PressLow Alarm Time	The Time when the PRESS LOW ALARM Alarm occurred (Item 143) Default = 00:00:00 (Format: HH:MM:SS)
471	PressLow Alarm Date	The Date when the PRESS LOW ALARM Alarm occurred (Item 143). Date Format: Determined by Item 262. Default: 01-01-99.
472	PressHigh Alarm Time (Item 145).	The Time when the PRESS HIGH ALARM Alarm occurred Default = 00:00:00 (Format: HH:MM:SS)
473	PressHigh Alarm Date	The Date when the PRESS HIGH ALARM Alarm occurred (Item 145). Date Format: Determined by Item 262. Default: 01-01-99.
474	TempLow Alarm Time	The Time when the TEMP LOW ALARM Alarm Occurred (Item 144) Default = 00:00:00 (Format: HH:MM:SS)
475	TempLow Alarm Date	The Date when the TEMP LOW ALARM Alarm occurred (Item 144). Date Format: Determined by Item 262. Default: 01-01-99.

Item No.	Item Name	Description
476	Temp High Alarm Time	The Time when the TEMP HIGH ALARM Alarm occurred (Item 146). Default: 00:00:00 (Format: HH:MM:SS)
477	Temp High Alarm Date	The Date when the TEMP HIGH ALARM Alarm occurred (Item 146). Date format: Determined by Item 262, Default =01-01-99
478	Daily CorVol Alarm Time	The Time when the DAILY COR VOL ALM Alarm occurred (Item 222). Default: 00:00:00 (Format: HH:MM:SS)
479	Daily CorVol Alarm Date	The Date when the DAILY COR VOL ALM Alarm occurred (Item 222). Date Format: Determined by Item 262, Default = 01-01-99
482	Default Display	Parameter used to select which item will be displayed on the LCD when the instrument is in corrector mode. Any item may be selected, but traditionally corrected volume is displayed Default = 000 (Corrected Volume)
483	Alarm Message	Optional eight character user-defined text string displayed on the LCD in 8-second intervals when an alarm has occurred. i.e. typing the word 'ALARM' in item 483 will cause the display to alternate between corrected volume and ALARM every 8 seconds. Default = (blank)
484	Alarm Channel Control	Selection to determine if the Alarm Channel at TB2 is used as an alarm pulse output or used to control power of an external device. (i.e. cellular phones, modems) Select: 0 -Alarm Pulse Output Default 1 -Modem Power Control
485	Call-out Stop Time	Parameter used to set the time of day to end the call-out cycle when using modem power control.
486	Modem AT Enable	Selection to determine the type of call-in initiated by the instrument. Select: 0 -Call-in via Alarm Pulse Default 1 -Call-in via AT commands
487	Call-in Keep Alive Time	Parameter used to set the amount of time to leave the system powered up after a call-in (allowing the host to call back). Time is specified in minutes. Default = 15 minutes

Item No.	Item Name	Description
488	Call-out Repeat Interval	Parameter used to set the amount of time to wait until repeating the Call-out Window set by the Call-out Keep Alive Time (Item 489). Time is specified in minutes Note: the value set in Item 488 must be greater than the value set in Item 489. Default = 0
489	Call-out Keep Alive Time	Parameter used to set the amount of time to power the external device to allow a host to call-out to the instrument. Time is specified in minutes. Default = 0
490	Call-out Start Time	Parameter used to set the time of day to start the call-out cycle when using modem power control.
491	Modem Init String	Character string used to initialize instrument modem at the beginning of call-in. Default = &f
492	Modem Dial String	Character string used to initiate dialing Default = ATDT
493	Alarm Call-In#	Telephone number dialed when Alarm call-in is executed.
494	Modem Hang-Up	Character string used by to disconnect modem communications Default = ATH
495	Modem Retry Interval A	Retry period A, in minutes. Intended to be the primary retry. Default = 5
496	Modem Retry Interval B	Retry period B, in minutes. Intended to be the secondary retry. Default = 1440
497	Modem Retry Count A	Number of period A retries Default = 3
658	P1 Interval High Time	Time when the highest value of item 008 occurred during the log interval Default = 00 00 00
660	P1 Interval Low Time	Time when the lowest value of item 008 occurred during the log interval Default = 00 00 00

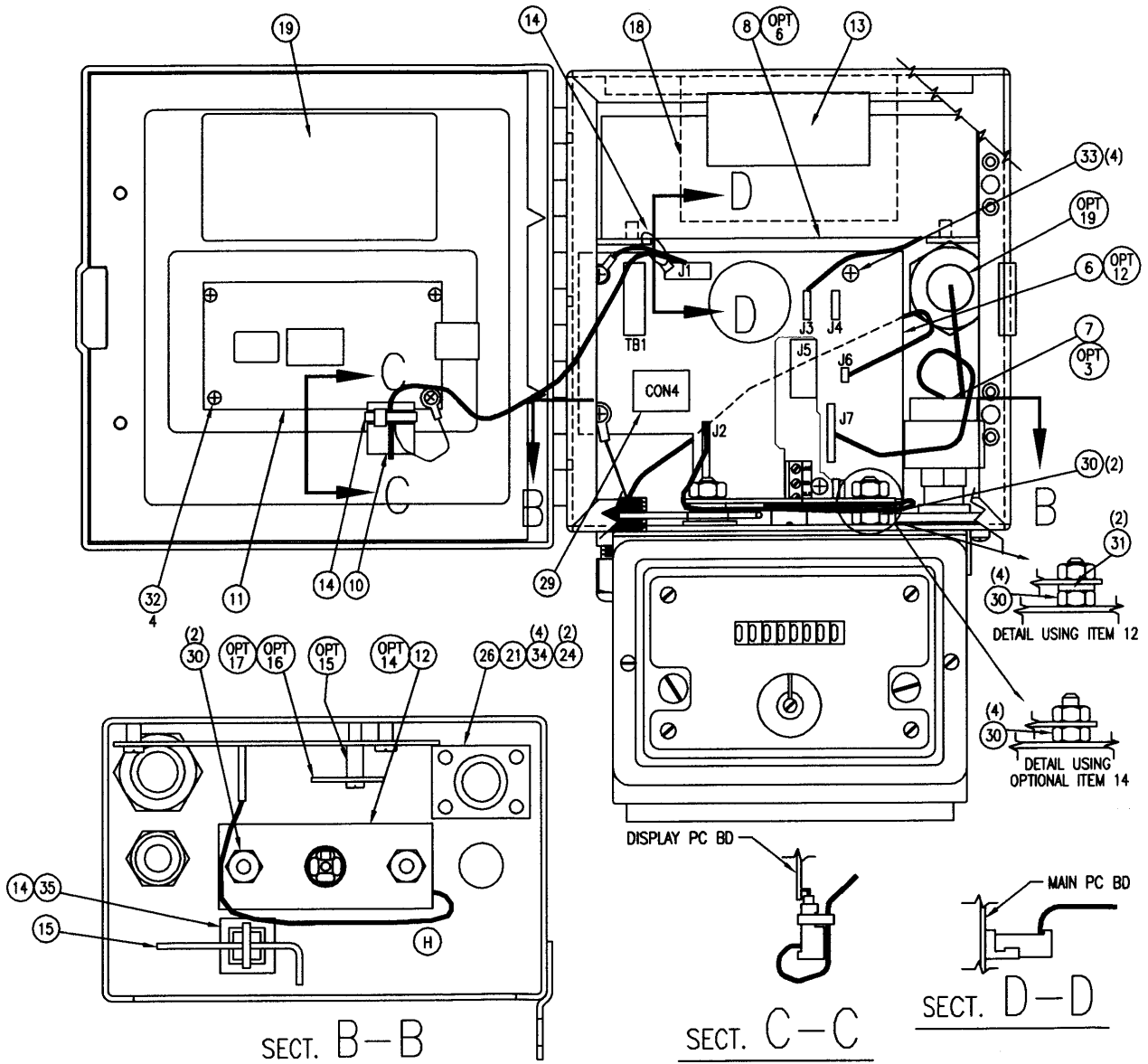

Meter Mount Mini-Max (Internal)

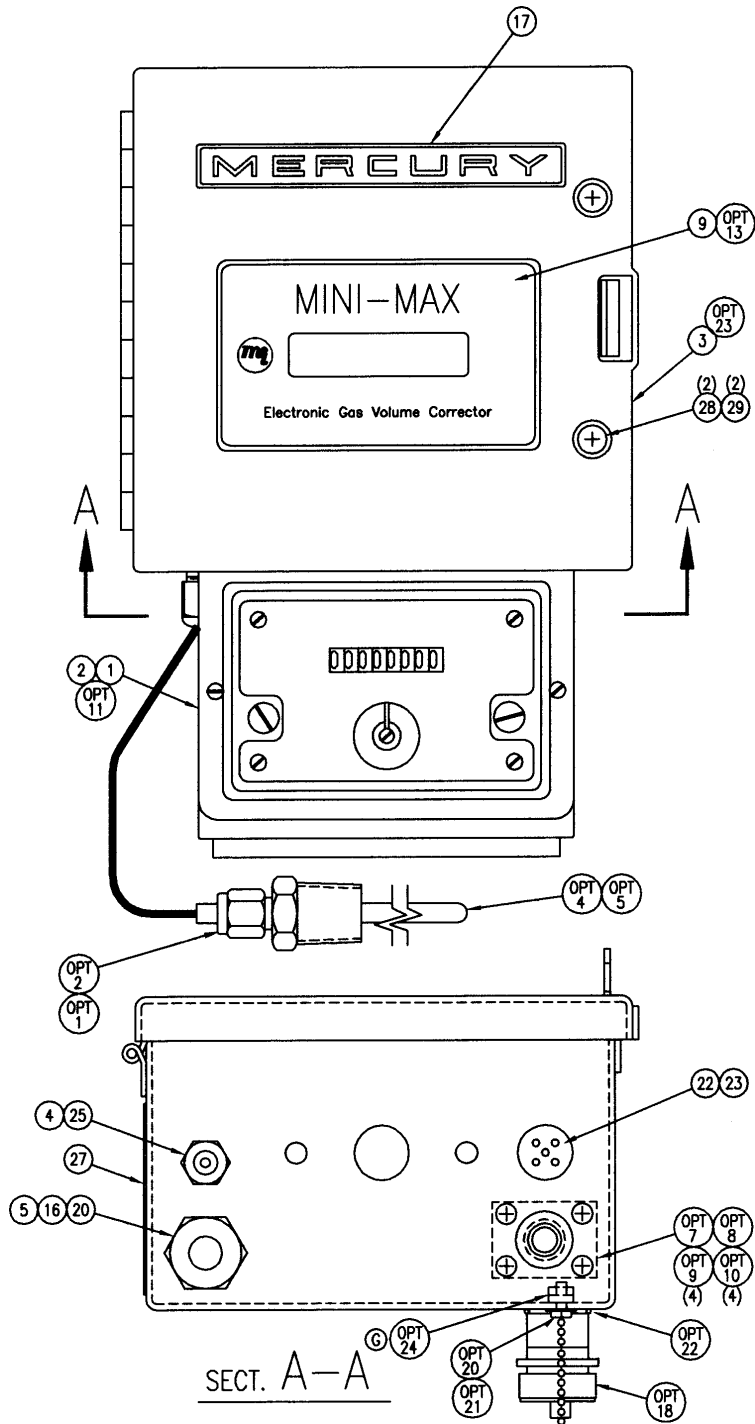

**Meter Mount Mini-Max
(External)**

Mini-Max Meter Mount Parts List			
Item	Qty	Part #	Description
1	1	20-2365	Mounting Kit, Standard
2	1	20-9038	UMB Assembly, Mini-Max
3	1	20-9031	Case, Mini-Max
4	1	20-8718	Plug, Strain Relief - 3/16 dia
5	1	20-7552	Plug, Strain Relief - 3/18 dia
6	1	40-2572-1	Mainboard, Mini-Max
7	1	40-2453	Transducer Assembly
8	1	40-2595	Battery Pack, Receptacle, Mini-Max
9	1	40-2597	Display window and switch assembly
10	1	40-2600	Cable, Display
11	1	40-2625	Display, 8 character alphanumeric
12	1	40-2613	Input Switch Board, Mini-Max
13	1	20-9170	Pad, Foam, Black
14	3	20-3827	Cable Tie
15	1	20-1428	Wrench, Bristol
16	1	20-7895	Nut, 1/2 NPT
17	1	20-8283	Nameplate
18	1	20-8402	Label, Made in USA
19	1	20-8453	Label, Serial #
20	1	20-8911	Fitting, Strain Relief .20-.35
21	1	20-8981	Gasket, Case Connector
22	1	20-9281	Vent
23	1	20-3737	Filter, Vent
24	2	20-8159	Washer, #8 Internal Lock
25	1	20-9049	Fitting, Strain Relief .18-.31
26	1	20-9054	Assembly, Pressure Case Connector
27	1	20-9090	Label, UL/cUL - Mini-Max
28	2	20-9328	Washer, Neoprene Bonded
29	2	60-1343	Screw, #10-24 x 1 1/4" Pan Hd Phillips
30	4	60-1607	Nut, Hex 1/4-20
31	2	20-9292	Washer, 1/4 Flat Nylon
32	4	60-4161	Screw, PN #4-40 x 1/4
33	4	60-4219	Screw, PN #6-32 x 1/4
34	4	60-4334	Screw, Fil #8-32 x 1/4
35	1	40-1329	Holder, Cable Tie
36			
37			
38			

Mini-Max Meter Mount Options			
Item	Qty	Part #	Description
1	1	20-7902	Fitting, Male Conn. 1/4T - 1/2MNPT Metal
2	1	20-8739	Fitting, Male Conn. 1/4T - 1/2MNPT Nylon
3	1	40-1428	Pressure Transducers
4	1	40-1432	Armored Temperature Probe
5	1	40-2583	Armorless Temperature Probe
6	1	40-2596	Battery Pack, Disposable, Mini-Max
7	1	20-8978	Plate, Cover - Transducer
8	1	20-8981	Gasket, Cover - Transducer
9	4	60-1303	Screw, Fil #8-32 x 3/8
10	4	60-1605	Nut, Hex #8-32
11	1	20-7558	Optional Indexes
12	1	40-2572-2	Mainboard, Mini-Max AT
13	1	40-2733	Display Window & Switch Assembly, Mini-Max AT
14	1	40-2678	Input Switch Board with Terminal Block
15	1	20-7284	Standoff, #6-32 x 7/16 M-F
16	1	40-2717-1	Serial I/O Board
17	1	40-2717-2	Serial I/O Board w/terminal block
18	1	40-1576	Cap & Chain Assembly
19	1	60-1629	Locknut, #3/4-20 Brass
20	1	60-1208	Screw, PN #6-32 x 3/8
21	1	60-1604	Nut, Hex #6-32
22	1	20-9456	O-Ring, 5/8 I.D. x 1/16
23	1	20-9150	Enclosure, Mini-Max w/Connector

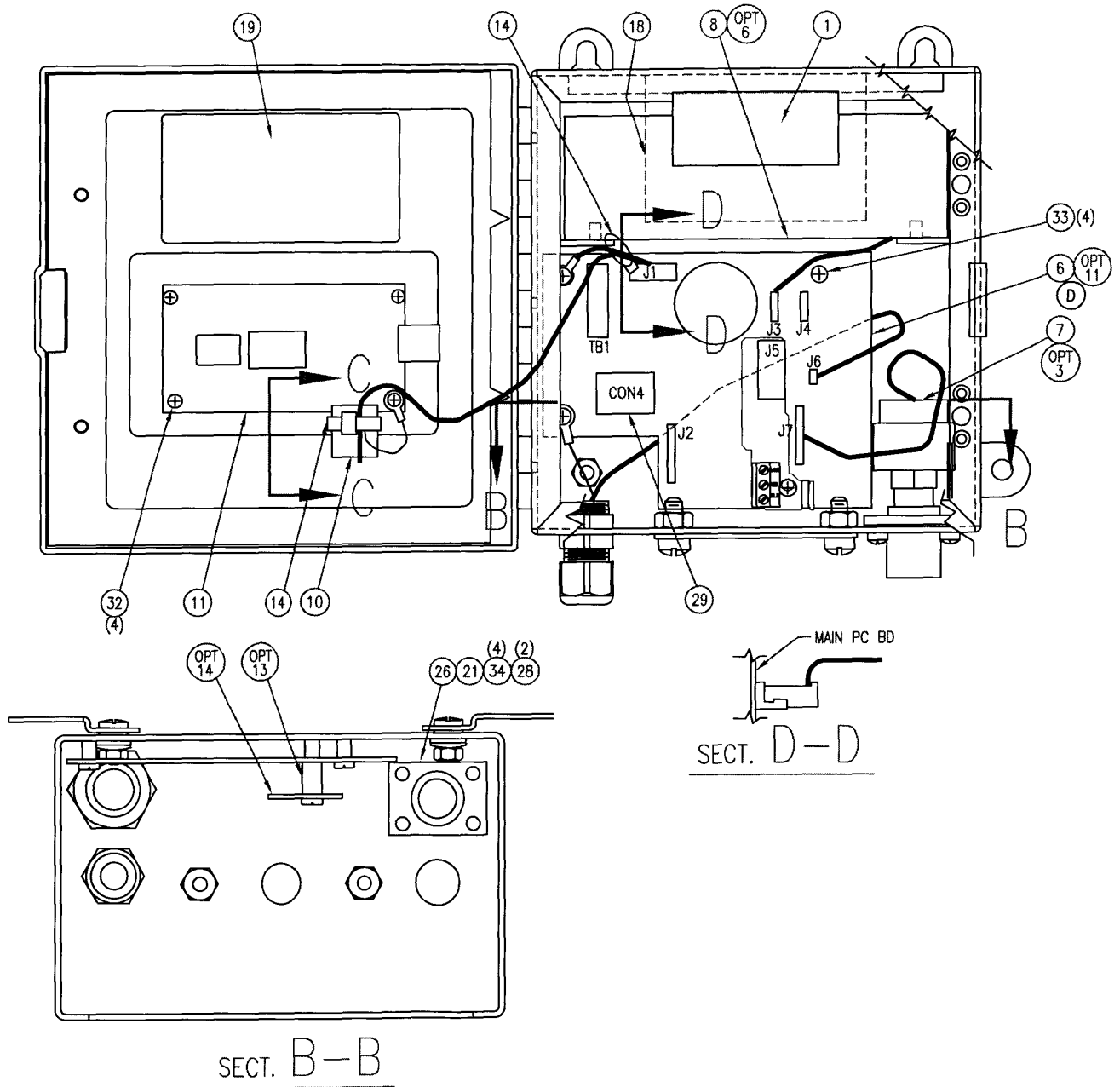

Wall Mount Mini-Max (Internal)

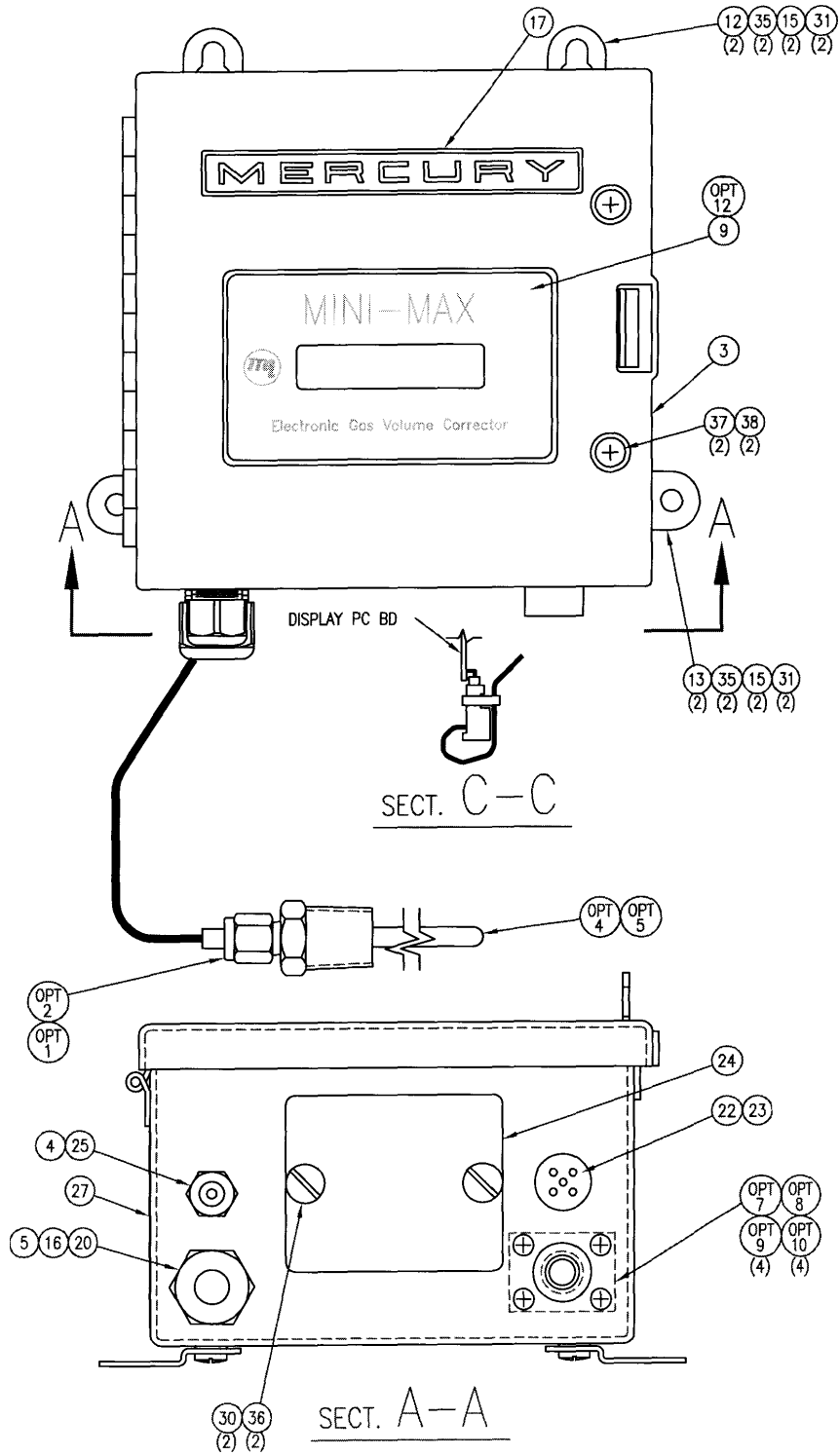

**Wall Mount Mini-Max
(External)**

Mini-Max Wall Mount Parts List			
Item	Qty	Part #	Description
1	1	20-9170	Pad, Foam, Black
2			
3	1	20-9309	Case, Mini-Max Wall Mount
4	1	20-8718	Plug, Strain Relief - 3/16 dia
5	1	20-7552	Plug, Strain Relief - 3/18 dia
6	1	40-2572-1	Mainboard, Mini-Max
7	1	40-2453	Transducer Assembly
8	1	40-2595	Battery Pack, Receptacle, Mini-Max
9	1	40-2597	Display window and switch assembly
10	1	40-2600	Cable, Display
11	1	40-2625	Display, 8 character alphanumeric
12	2	20-1586	Hangar, Case Top
13	2	20-1587	Hangar, Case Bottom
14	2	20-3827	Cable Tie
15	4	20-5300	Washer, #10 External Lock
16	1	20-7895	Nut, 1/2 NPT
17	1	20-8283	Nameplate
18	1	20-8402	Label, Made in USA
19	1	20-8453	Label, Serial #
20	1	20-8911	Fitting, Strain Relief .20-.35
21	1	20-8981	Gasket, Case Connector
22	1	20-9281	Vent
23	1	20-3737	Filter, Vent
24	1	20-9074	Plate, UMB Weather Cover
25	1	20-9049	Fitting, Strain Relief .18-.31
26	1	20-9054	Assembly, Pressure Case Connector
27	1	20-9090	Label, UL/cUL - Mini-Max
28	2	20-8159	Washer, #8 Internal Lock
29	1	40-2657	Plug, 4 Pin Terminal Block
30	2	60-1607	Nut, Hex 1/4-20
31	4	60-1609	Nut, Hex #10-32
32	4	60-4161	Screw, PN #4-40 x 1/4
33	4	60-4219	Screw, PN #6-32 x 1/4
34	4	60-4334	Screw, Fil #8-32 x 1/4
35	4	60-1356	Screw, Bd #10-32 x 1/2
36	2	60-1402	Screw, Fil 1/4-20 x 1/2
37	2	20-9328	Washer, Neoprene Bonded
38	2	60-1343	Screw, #10-24 x 1 1/4" Pan Hd Phillips

Mini-Max Wall Mount Options			
Item	Qty	Part #	Description
1	1	20-7902	Fitting, Male Conn. 1/4T - 1/2MNPT Metal
2	1	20-8739	Fitting, Male Conn. 1/4T - 1/2MNPT Nylon
3	1	40-1428	Pressure Transducers
4	1	40-1432	Armored Temperature Probe
5	1	40-2583	Armorless Temperature Probe
6	1	40-2596	Battery Pack, Disposable, Mini-Max
7	1	20-8978	Plate, Cover - Transducer
8	1	20-8981	Gasket, Cover - Transducer
9	4	60-1303	Screw, Fil #8-32 x 3/8
10	4	60-1605	Nut, Hex #8-32
11	1	40-2572-2	Mainboard, Mini-Max AT
12	1	40-2733	Display Window & Switch Assembly, Mini-Max AT
13	1	20-7284	Standoff, #6-32 x 7/16 M-F
14	1	40-2678	Input Switch Board with Terminal Block
15	1	40-2717-2	Serial I/O Board w/terminal block

NON-HAZARDOUS LOCATION

HAZARDOUS LOCATION
CLASS 1, DIV. 1, ZONE 0,1
GROUP D

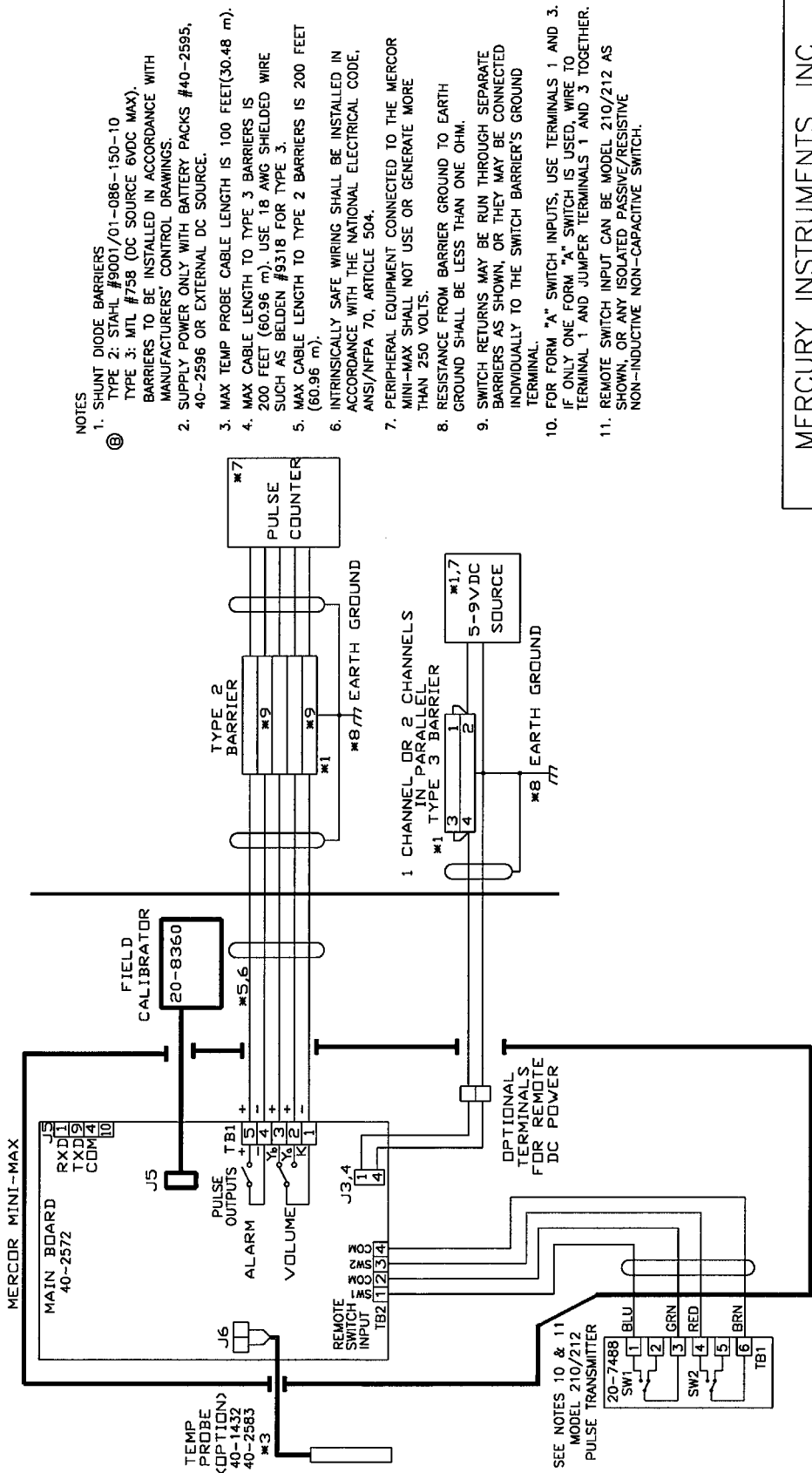

- NOTES
- SHUNT DIODE BARRIERS
TYPE 2: STAHL #9001/01-086-150-10
TYPE 3: MIL #75B (DC SOURCE 6VDC MAX).
BARRIERS TO BE INSTALLED IN ACCORDANCE WITH MANUFACTURERS' CONTROL DRAWINGS.
 - SUPPLY POWER ONLY WITH BATTERY PACKS #40-2595, 40-2596 OR EXTERNAL DC SOURCE.
 - MAX TEMP PROBE CABLE LENGTH IS 100 FEET (30.48 m).
 - MAX CABLE LENGTH TO TYPE 3 BARRIERS IS 200 FEET (60.96 m). USE 18 AWG SHIELDED WIRE SUCH AS BELDEN #9318 FOR TYPE 3.
 - MAX CABLE LENGTH TO TYPE 2 BARRIERS IS 200 FEET (60.96 m).
 - INTRINSICALLY SAFE WIRING SHALL BE INSTALLED IN ACCORDANCE WITH THE NATIONAL ELECTRICAL CODE, ANSI/NFPA 70, ARTICLE 504.
 - PERIPHERAL EQUIPMENT CONNECTED TO THE MERCOR MINI-MAX SHALL NOT USE OR GENERATE MORE THAN 250 VOLTS.
 - RESISTANCE FROM BARRIER GROUND TO EARTH GROUND SHALL BE LESS THAN ONE OHM.
 - SWITCH RETURNS MAY BE RUN THROUGH SEPARATE BARRIERS AS SHOWN, OR THEY MAY BE CONNECTED INDIVIDUALLY TO THE SWITCH BARRIER'S GROUND TERMINAL.
 - FOR FORM "A" SWITCH INPUTS, USE TERMINALS 1 AND 3. IF ONLY ONE FORM "A" SWITCH IS USED, WIRE TO TERMINAL 1 AND JUMPER TERMINALS 1 AND 3 TOGETHER.
 - REMOTE SWITCH INPUT CAN BE MODEL 210/212 AS SHOWN, OR ANY ISOLATED PASSIVE/RESISTIVE NON-INDUCTIVE NON-CAPACITIVE SWITCH.

MERCURY INSTRUMENTS, INC.	
MERCOR MINI-MAX INSTALLATION, (DIV. 1, ZONE 0,1) HAZARDOUS LOCATIONS	
REFERENCE:	SCALE: NONE
	FAR 12-07-99
	APP'D BY: CN-1467
SIZE: A	PAGE 1
40-2643-B	

B	REMOVED STAHL B901 BARRIER	CN-1484	08/30/00 TAH
A	ORIGINAL RELEASE	CN-1467	06/16/00 TAH

HAZARDOUS LOCATION

CLASS I, DIV. 2, ZONE 2
GROUP D

MERCOR MINI-MAX

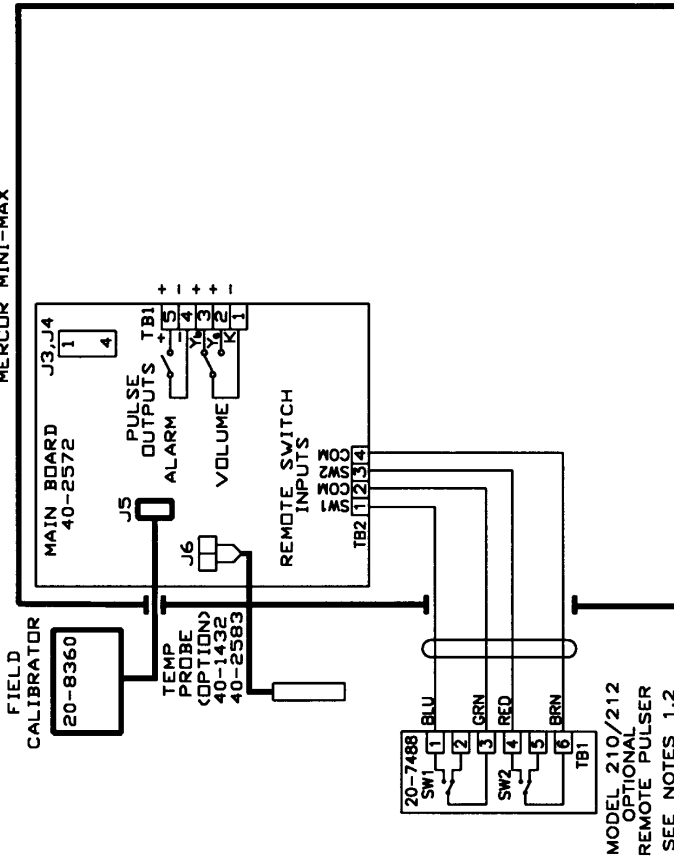

MODEL 210/212
OPTIONAL
REMOTE PULSER
SEE NOTES 1,2

NON-HAZARDOUS LOCATION

NOTES

1. FOR FORM "A" SWITCH INPUTS, USE TERMINALS 1 AND 3. IF ONLY ONE FORM "A" SWITCH IS USED, WIRE TO TERMINAL 1 AND JUMPER TERMINALS 1 AND 3 TOGETHER.
2. REMOTE SWITCH INPUT CAN BE MODEL 210/212 AS SHOWN, OR ANY ISOLATED PASSIVE/RESISTIVE NON-INDUCTIVE NON-CAPACITIVE SWITCH.

MERCURY INSTRUMENTS, INC.	
MERCOR MINI-MAX INSTALLATION, (DIV. 2, ZONE 2) HAZARDOUS LOCATION	
REFERENCE:	SCALE: NONE
BY: FAR	12-07-99
APP'D BY:	
SIZE: A	40-2644

NON-HAZARDOUS LOCATION

HAZARDOUS LOCATION
CSA

CLASS I, DIV. 1, GROUP D
CLASS I, ZONE 0, GROUP IIA

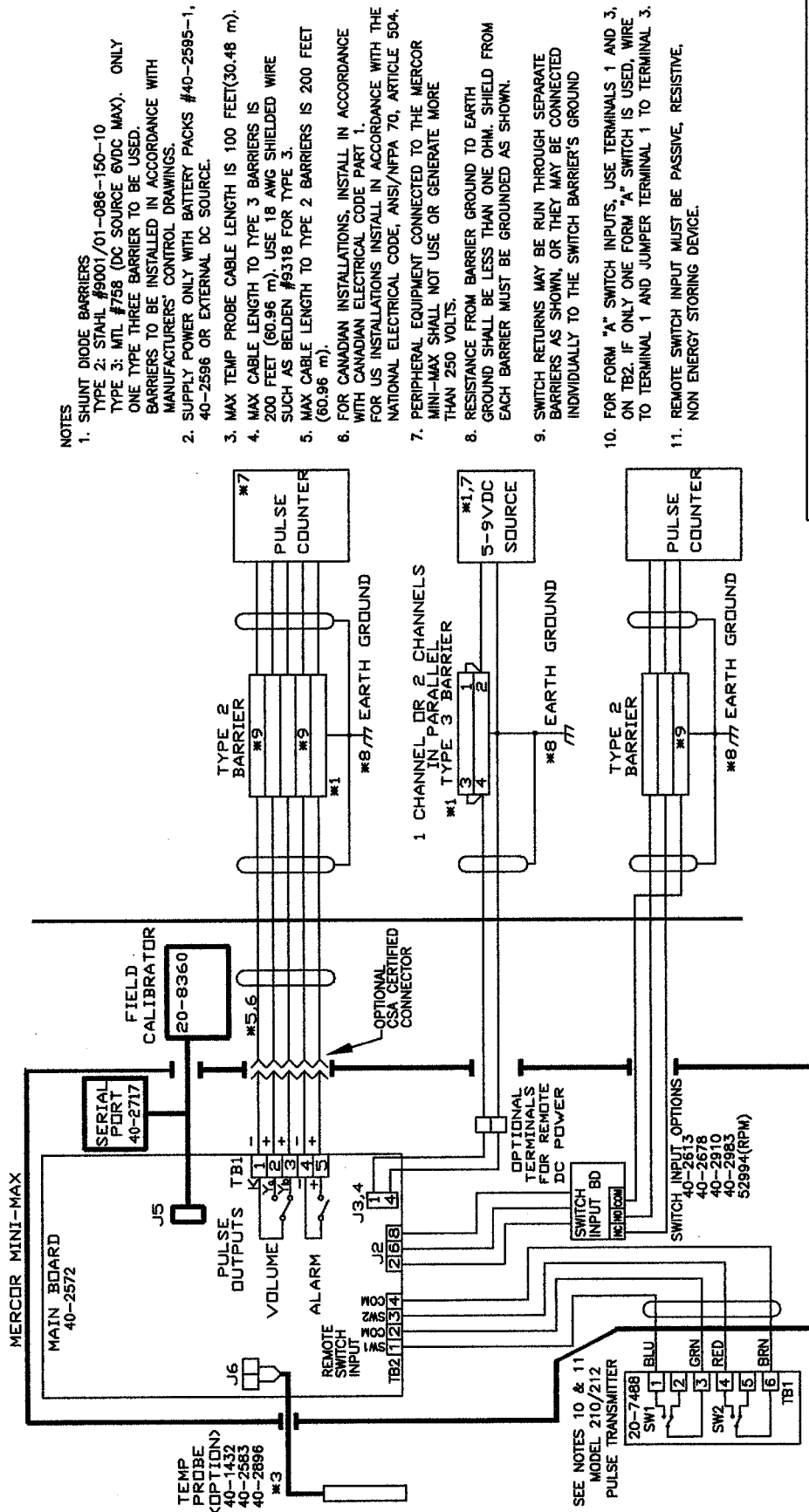

- NOTES**
1. SHUNT DIODE BARRIERS
TYPE 2: STAHL #9001/01-086-150-10
TYPE 3: MITL #758 (DC SOURCE 6VDC MAX). ONLY ONE TYPE THREE BARRIER TO BE USED.
BARRIERS TO BE INSTALLED IN ACCORDANCE WITH MANUFACTURERS' CONTROL DRAWINGS.
 2. SUPPLY POWER ONLY WITH BATTERY PACKS #40-2585-1, 40-2596 OR EXTERNAL DC SOURCE.
 3. MAX TEMP PROBE CABLE LENGTH IS 100 FEET(30.48 m).
 4. MAX CABLE LENGTH TO TYPE 3 BARRIERS IS 200 FEET (60.96 m). USE 18 AWG SHIELDED WIRE SUCH AS BELDEN #9318 FOR TYPE 3.
 5. MAX CABLE LENGTH TO TYPE 2 BARRIERS IS 200 FEET (60.96 m).
 6. FOR CANADIAN INSTALLATIONS, INSTALL IN ACCORDANCE WITH CANADIAN ELECTRICAL CODE PART 1.
FOR US INSTALLATIONS INSTALL IN ACCORDANCE WITH THE NATIONAL ELECTRICAL CODE, ANSI/NFPA 70, ARTICLE 504.
 7. PERIPHERAL EQUIPMENT CONNECTED TO THE MERCOR MINI-MAX SHALL NOT USE OR GENERATE MORE THAN 250 VOLTS.
 8. RESISTANCE FROM BARRIER GROUND TO EARTH GROUND SHALL BE LESS THAN ONE OHM. SHIELD FROM EACH BARRIER MUST BE GROUNDED AS SHOWN.
 9. SWITCH RETURNS MAY BE RUN THROUGH SEPARATE BARRIERS AS SHOWN, OR THEY MAY BE CONNECTED INDIVIDUALLY TO THE SWITCH BARRIER'S GROUND.
 10. FOR FORM "A" SWITCH INPUTS, USE TERMINALS 1 AND 3, ON TB2. IF ONLY ONE FORM "A" SWITCH IS USED, WIRE TO TERMINAL 1 AND JUMPER TERMINAL 1 TO TERMINAL 3.
 11. REMOTE SWITCH INPUT MUST BE PASSIVE, RESISTIVE, NON ENERGY STORING DEVICE.

MERCURY INSTRUMENTS, INC.

MERCOR MINI-MAX INSTALLATION, CSA
(DIV. 1, ZONE 0) HAZARDOUS LOCATIONS

REFERENCE	SCALE	SRS	10/11/00
	NONE	APP'D BY:	CN-1506
SIZE:	A	PAGE	1

40-2803-C

C	ADDED 40-2983 AS SWITCH INPUT OPTION	CN-1714	5-21-03
B	ADDED SWITCH INPUT OPTIONS	CN-1644	5-21-02
A	ADD OPT. CONNECTOR	CN-1562	7-10-01

40-2804-C

HAZARDOUS LOCATION
 CSA
 CLASS 1, DIV. 2, GROUP D
 CLASS 1, ZONE 2, GROUP IIA

NON-HAZARDOUS LOCATION

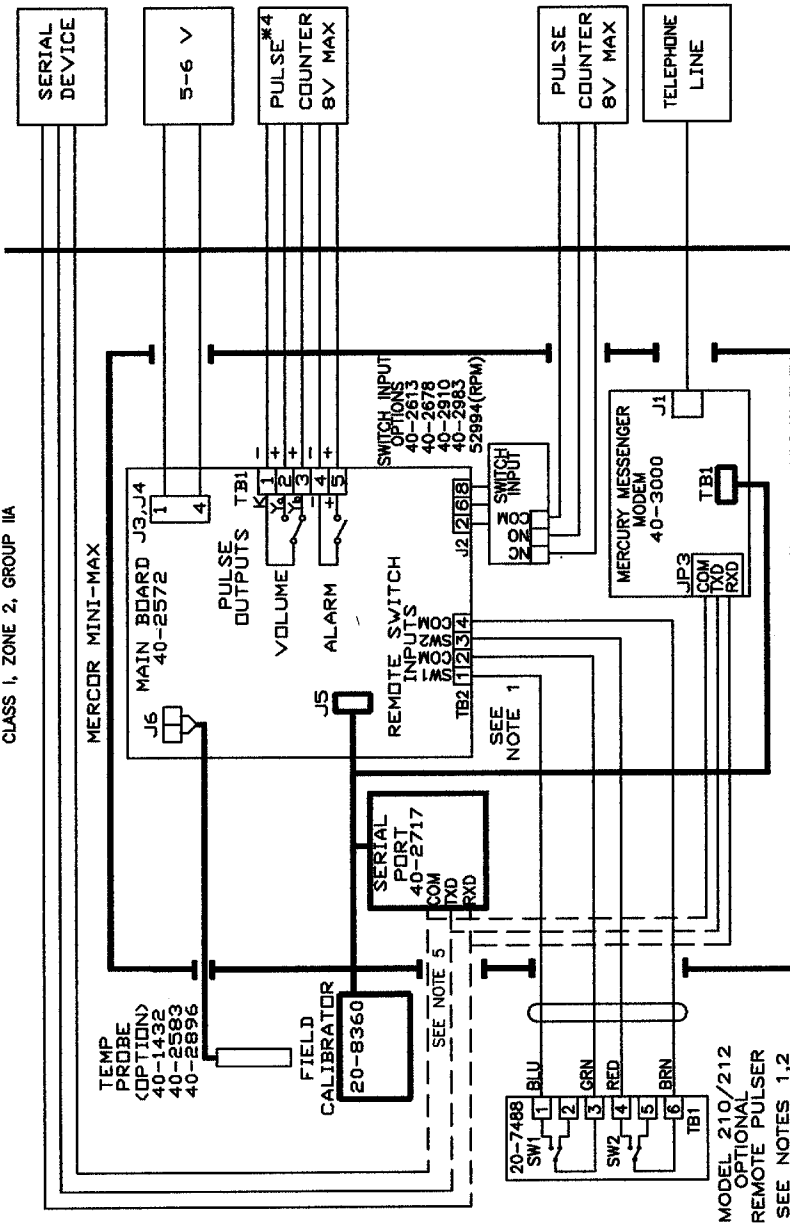

- NOTES
1. IF ONLY ONE FORM "A" SWITCH IS USED, CONNECT JUMPER FROM TB2-1 TO TB2-3.
 2. REMOTE SWITCH INPUT MUST BE PASSIVE, RESISTIVE, NON ENERGY STORING DEVICE.
 3. FOR CANADIAN INSTALLATIONS, INSTALL IN ACCORDANCE WITH CANADIAN ELECTRICAL CODE PART 1.
 4. FOR US INSTALLATIONS INSTALL IN ACCORDANCE WITH THE NATIONAL ELECTRICAL CODE ANSI/NFPA 70, ARTICLE 504. MAXIMUM VOLTAGE CONNECTED TO PULSE OUTPUTS SHOULD BE NO GREATER THAN 8 VDC.
 5. SERIAL PORT CONNECTION MUST BE MADE THROUGH CONDUIT OR THE AREA MUST BE DECLASSIFIED WHILE CONNECTION IS MADE. FOR MODEM INSTALLATIONS NOT INCLUDING SERIAL PORT 40-2717, A RIBBON CABLE WILL CONNECT JP3 ON MODEM TO J5 ON MAIN BOARD. FOR MODEM INSTALLATIONS INCLUDING SERIAL PORT, 40-2717-3 MUST BE USED. SERIAL SHORTING PLUG 40-2918 MUST BE USED TO CONNECT MODEM TO SERIAL BOARD.

MODEL 210/212
 OPTIONAL
 REMOTE PULSER
 SEE NOTES 1, 2

MERCURY INSTRUMENTS, INC.

MERCOR MINI-MAX INSTALLATION, CSA
 (DIV. 2, ZONE 2) HAZARDOUS LOCATION

REFERENCE: SCALE: BY/SRS 10/11/00
 APP'D BY: CN-1506

SIZE: A 40-2804-C

C	ADDED 40-2983 AS SWITCH INPUT OPTION	CN-1714	5-21-03 TAH
B	ADDED SWITCH INPUT OPTIONS	CN-1644	5-21-02 TAH
A	ADDED TEMP PROBE OPTION	CN-1607	12/07/01 TAH
	ADDED MESSENGER MODEM		

Alarms	35
Audit Trail	45
Battery Packs (Installing or Changing)	23
To install batteries in Alkaline Receptacle Pack	23
Calibration	46
2-Point Pressure Calibration (Defined)	47
2-Point Pressure Calibration (Gauge Transducers)	47
2-Point Pressure Calibration (Absolute Transducers)	49
2-Point Temperature Calibration (Defined)	51
2-Point Temperature Calibration (Procedure)	52
Connectors/Jumpers	8
Correction Factors to Metered Volume	12
Pressure Factor Fp	12
Temperature Factor Ft	12
Supercompressibility Factor Fpv	13
Drawing, Installation for CSA Div. 1 Hazardous Locations	106
Drawing, Installation for UL Div. 1 Hazardous Locations	104
Drawing, Installation for CSA Div. 2 Hazardous Locations	107
Drawing, Installation for UL Div. 2 Hazardous Locations	105
Firmware Reprogramming	55
How the Mini-Max Works	14
Drive Input	15
Pressure System	15
Temperature System	15
Supercompressibility Correction	16
LCD Display and Scroll Function	16
Computation Intervals	16
Access Levels for Operating Personnel	17
Installation (Standard)	20
Meter Rotation	20
To Change Rotation, if necessary	21

Installation (without an Instrument Drive)	21
Introduction	5
Item Code List	65
Meter Reader Mode (Detailed Description)	41
Gaining Access to Meter Reader Mode	41
Default Meter Reader Display	42
Live Parameter Display	45
Mini-Max Operating Modes	39
Corrector Mode	39
Meter Reader Mode	39
Level 1 Access Mode	40
Level 2 Access Mode	40
Modem, Communicating to the Mini-Max with	31
Modem Power Control	33
Parts List, Meter Mount Mini-Max	96
Parts List, Wall Mount Mini-Max	100
Pulse Outputs (Alarms)	35
Pulse Outputs (Volume)	36
Quick Start Guide	9
Serial Connector	26
Shutdown, Putting the Mini-Max into	54
Specifications	6
Receiving the Mini-Max	18
Function Check	18
Pressure Function Check - Gauge Transducer	18
Pressure Function Check - Absolute Transducer	18
Temperature Function	18
Volume Function Check	19
Unconfigured, Taking the Mini-Max	53

Find Out More:

To learn more about Mercury Instruments products, contact your Honeywell Process Solutions representative, visit www.mercuryinstruments.com or call **513-272-1111**.

Automation and Control Solutions

Honeywell Process Solutions
3940 Virginia Ave.
Cincinnati, OH 45227
513-272-1111
www.honeywell.com

Honeywell

MNL-MMX-1
October 2010
© 2010 Honeywell